

# Návod na montáž

# Náradie potrebné k montáži

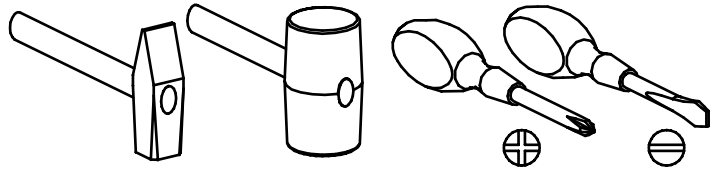
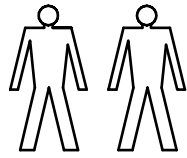

## SKRINA

## TORINO

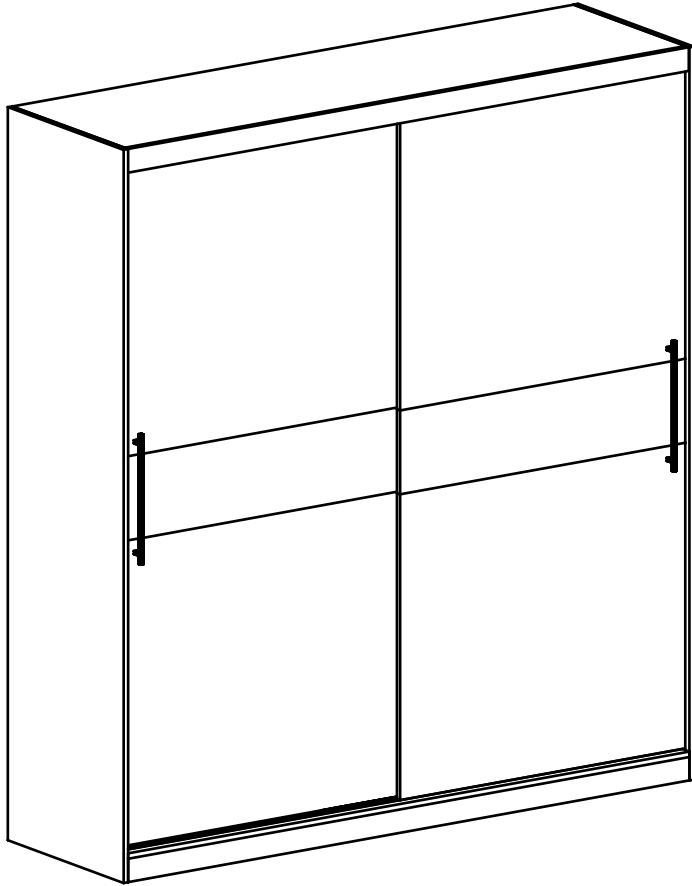

H

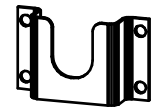

D

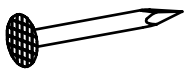

E



W



3 x 13 mm

S

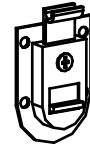

C

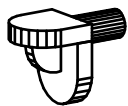

P

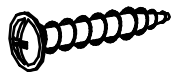

4 x 27 mm

N

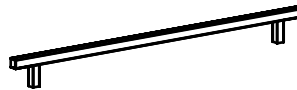

U

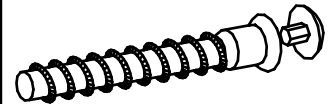

7 x 50 mm

A



T



F



4 x 13 mm

G



6 x 13 mm

M

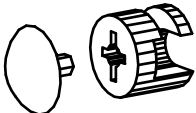

L



B

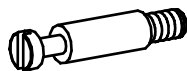

K



Z

1

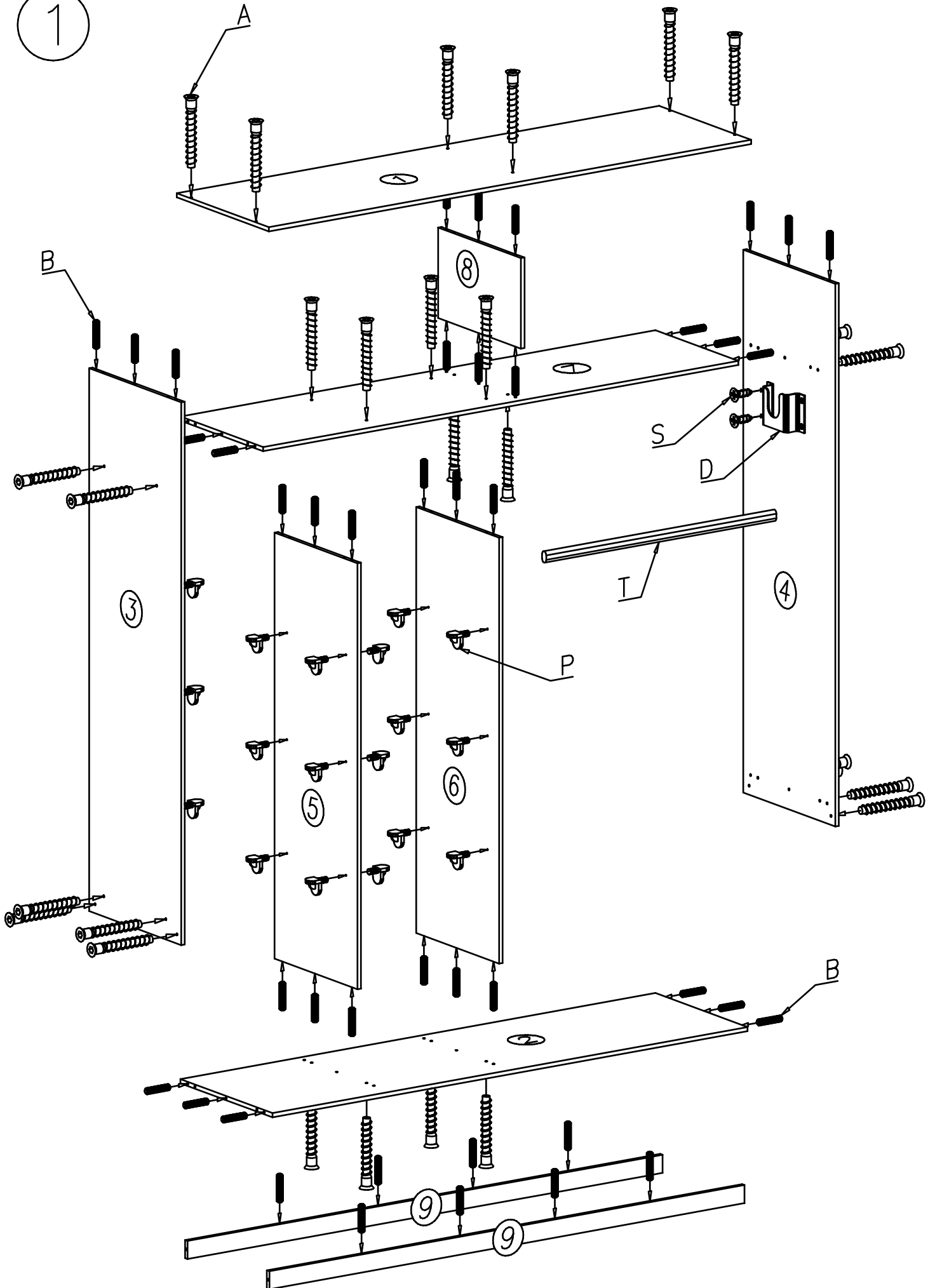

2

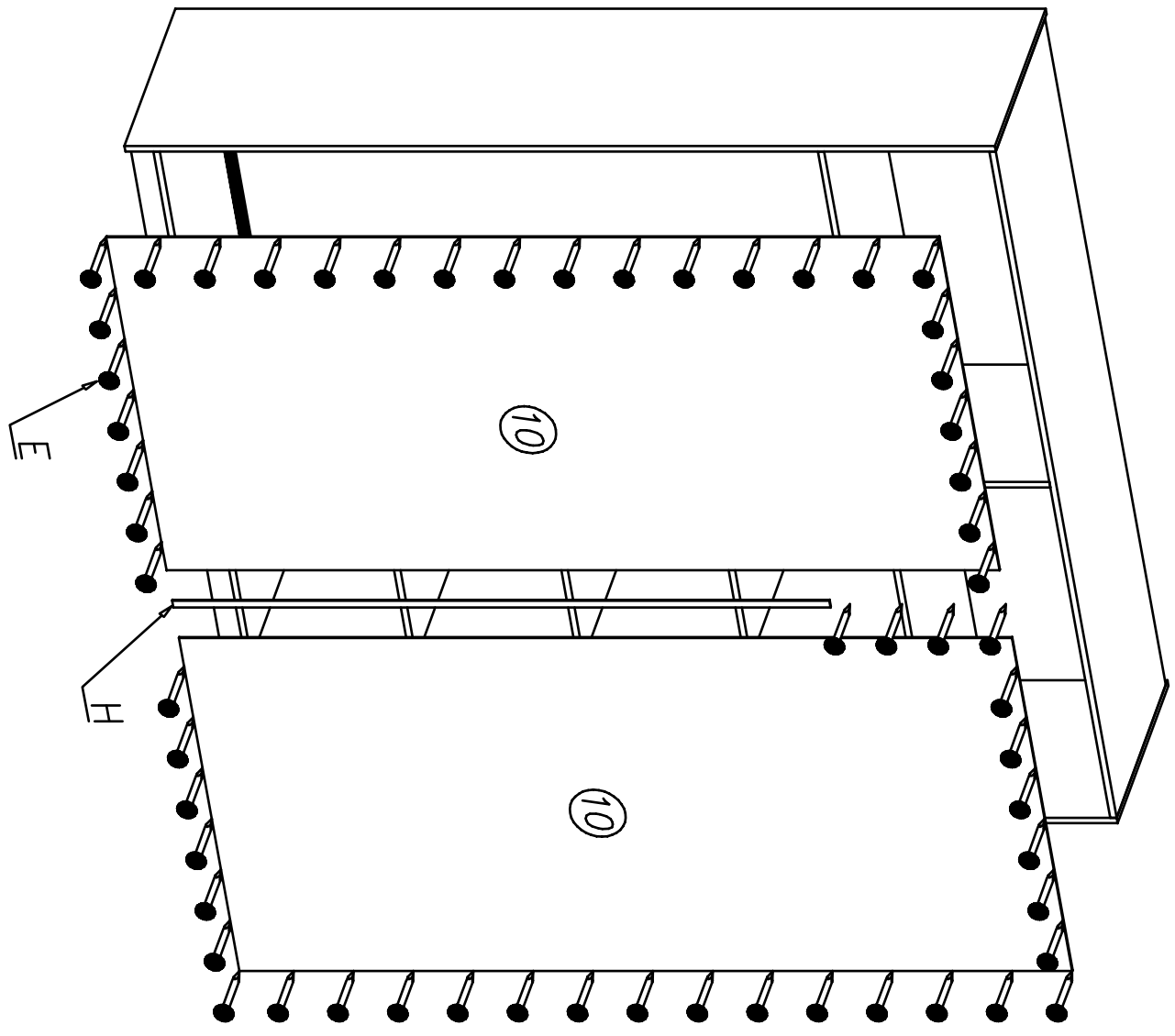

3

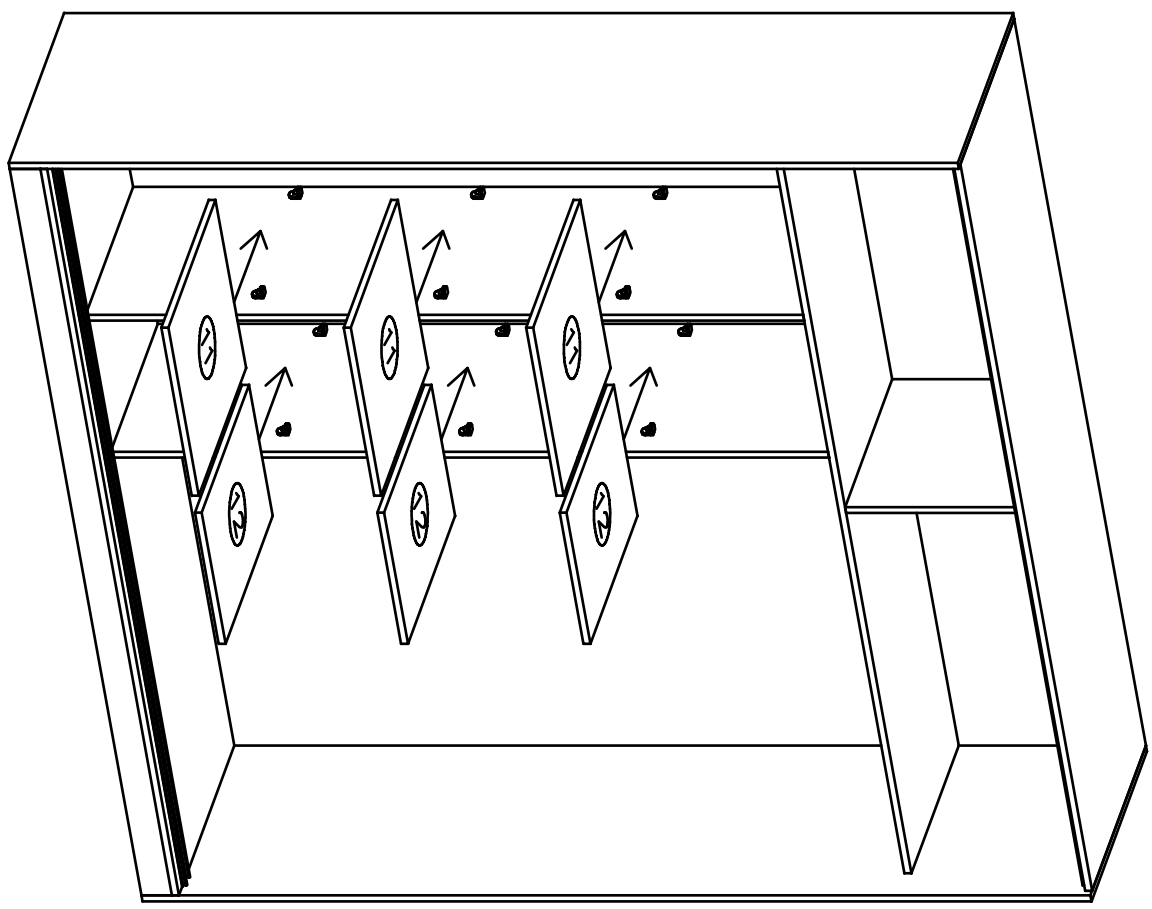

4

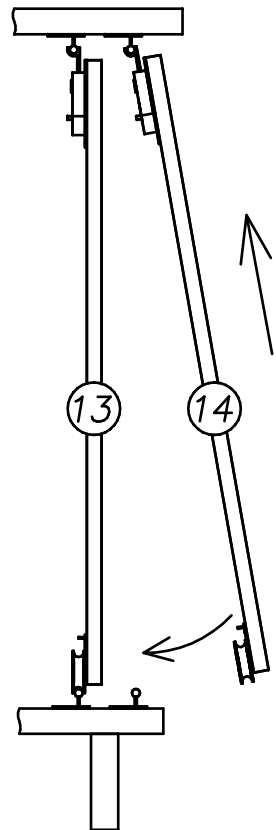
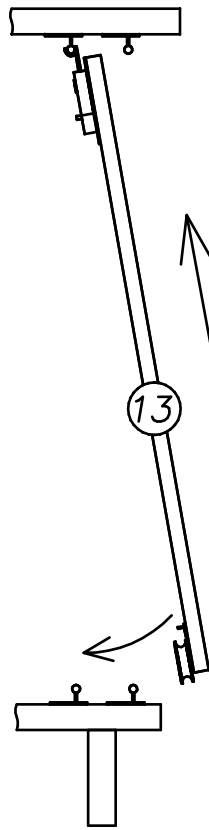
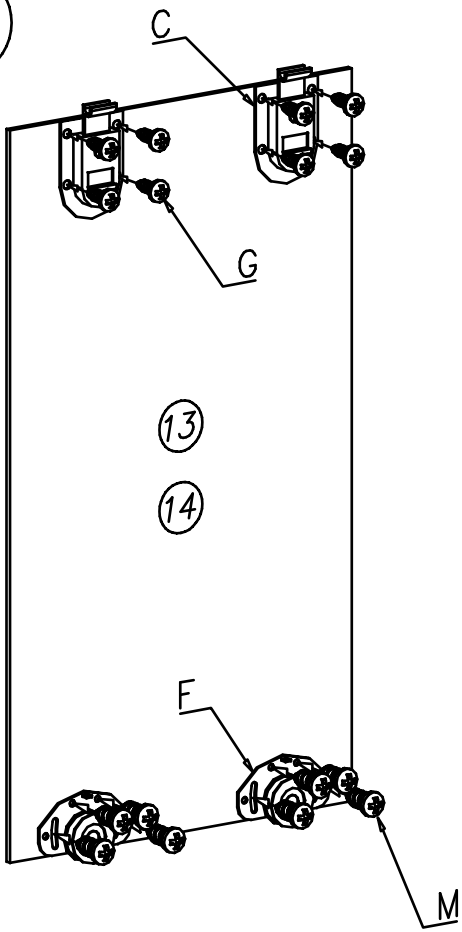

5

