

# MICHIGIN 90

Art.-Nr.

338 751  
338 752

	945
	750
	2052
	mm

1/8  
VO

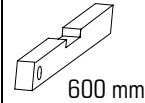
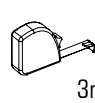
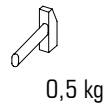
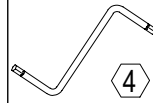
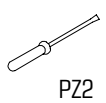
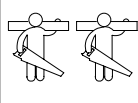

ID	ID			
19238	②	945*600*16	1x	1/1
19239	③	244*190*16	2x	1/1
19240	④	945*120*16	1x	1/1
19241	⑤	2004*194*16	1x	1/1
19242	⑥	2004*194*16	1x	1/1
19243	⑦	945*396*16	1x	1/1
19244	⑧	244*361*16	2x	1/1
19245	⑨	800*360*16	1x	1/1
19246	⑩	828*242*3	1x	1/1
19247	⑪	598*188*16	1x	1/1
19248	⑫	598*188*16	1x	1/1
19025	⑬	350*120*16	2x	1/1
19249	⑭	528*120*16	2x	1/1
19027	⑮	350*120*16	2x	1/1
19250	⑯	556*356*3	2x	1/1

**A**

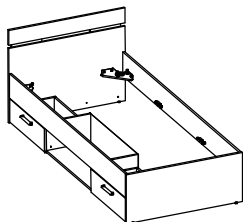

**B**

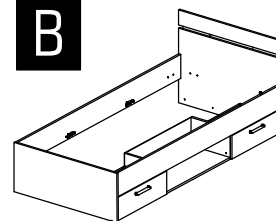

MM

120

110

100

90

80

70

60

50

40

30

20

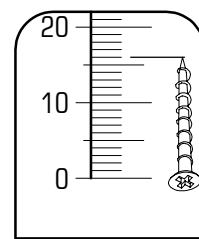
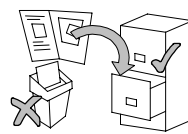
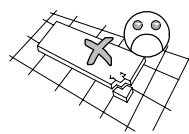
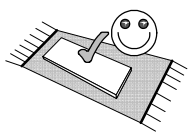
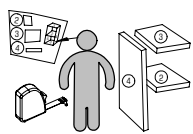
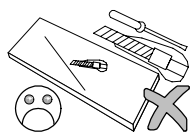
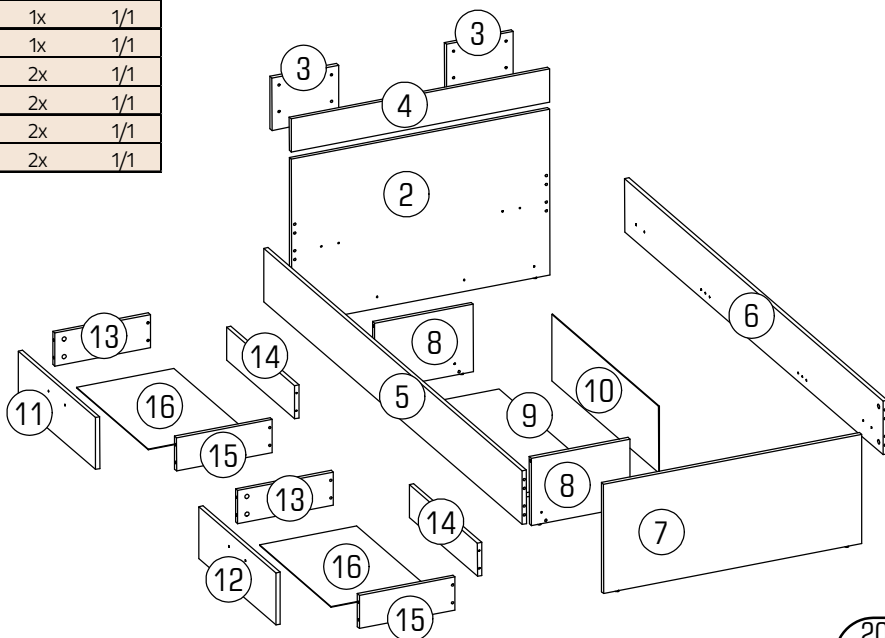

10

0



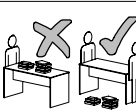
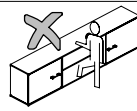
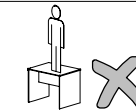
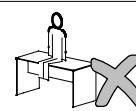
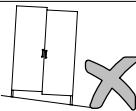
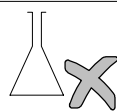

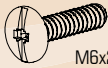
21102,00		Ø1,6x20	22232,00		Ø4,0x16	22243,00		Ø3,5x15	22300,00		Ø7x50	22430,00		Ø4x25	22453,00		M6x25	22705,00		Ø6,8x8	22707,00		Ø6,3x11
A	25x		B	4x		C	16x		D	16x		E	4x		F	8x		G	8x		H	16x	
22800,01		4	24091,00		Ø10x11	27000,00		Ø8x30	30091,00		8x	70013,01		Ø15x13	70021,01		14x		Q	8x		R	4x
J	1x		K	8x		L	8x		M	8x		N	14x		P	14x		Q	8x		R	4x	
31108,01		44x23x23	32030,00		L=150	33006,01		L=350	33006,01		L=350												
S	2x		T	2x		U	2x		V	2x													

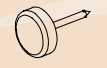

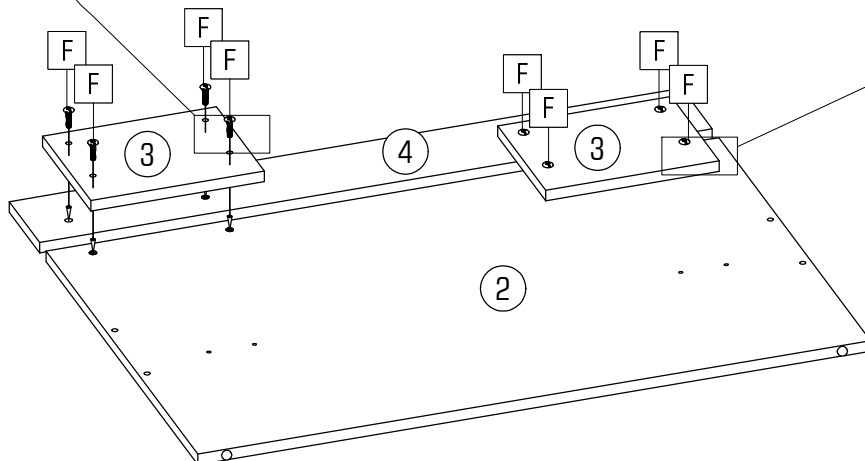
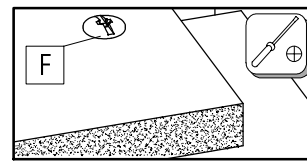
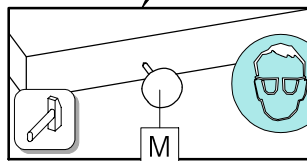
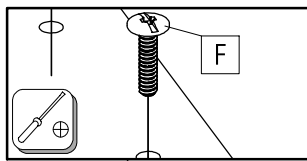
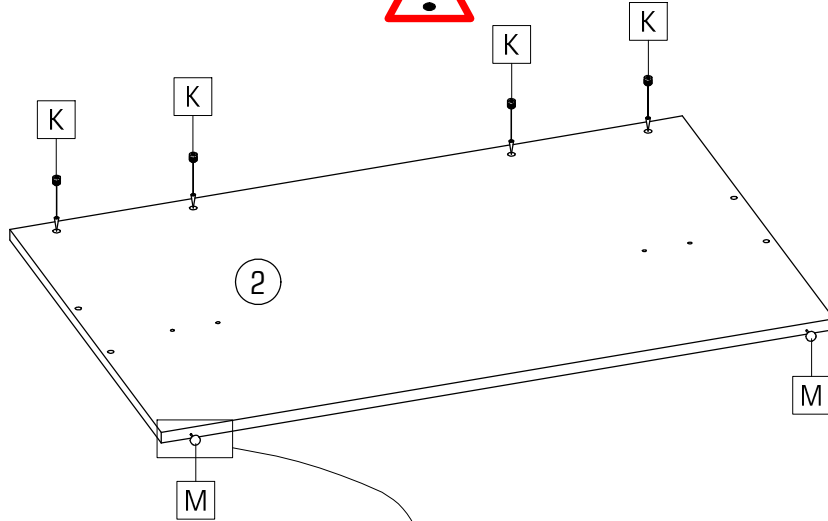
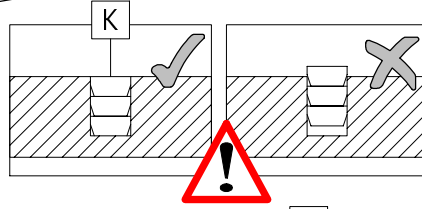
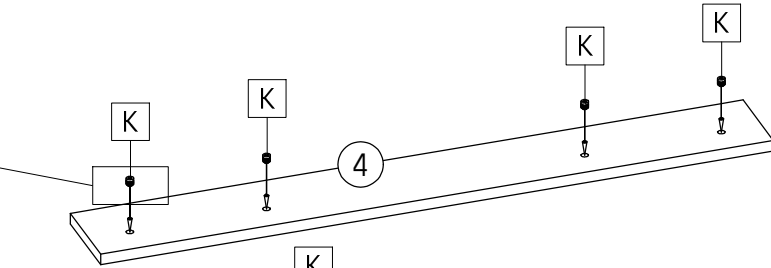
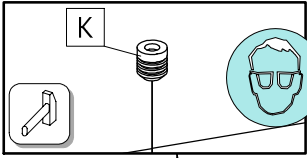
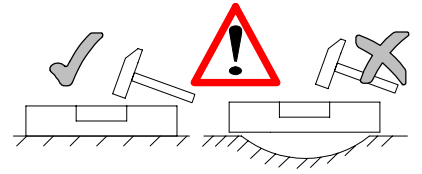
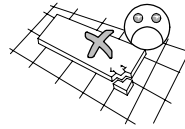
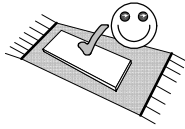
		
M6x25	Ø10x11	
F 8x	K 8x	M 2x

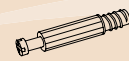

			
L	M	N	P
8x	2x	4x	4x

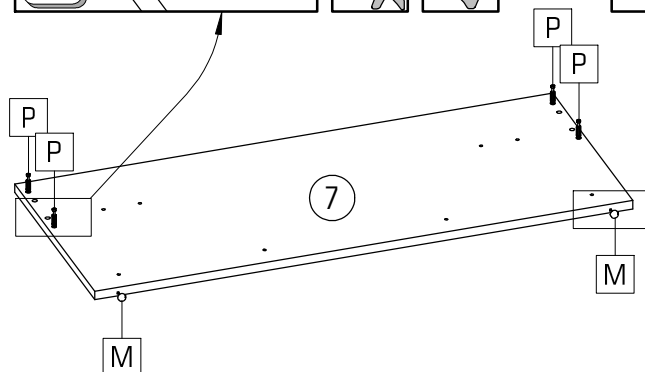
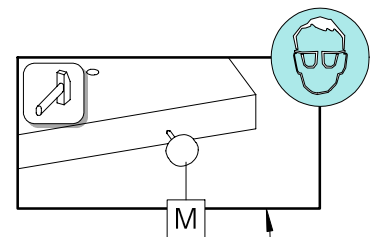
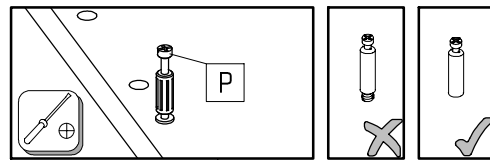
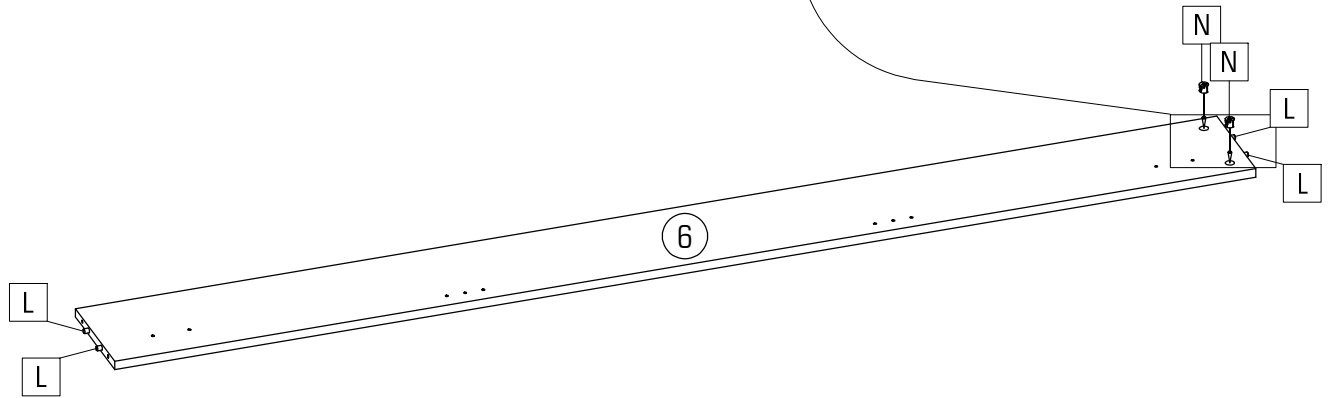
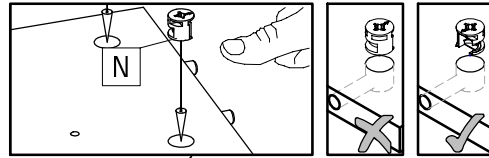
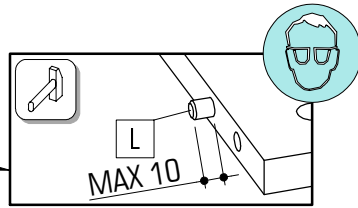
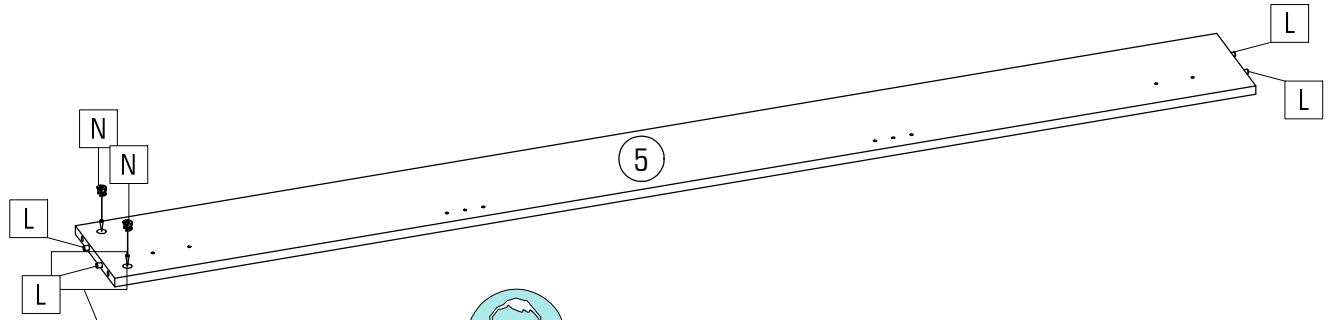
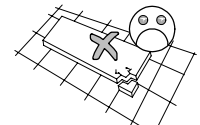
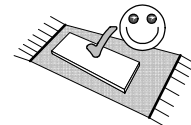





Ø7x50

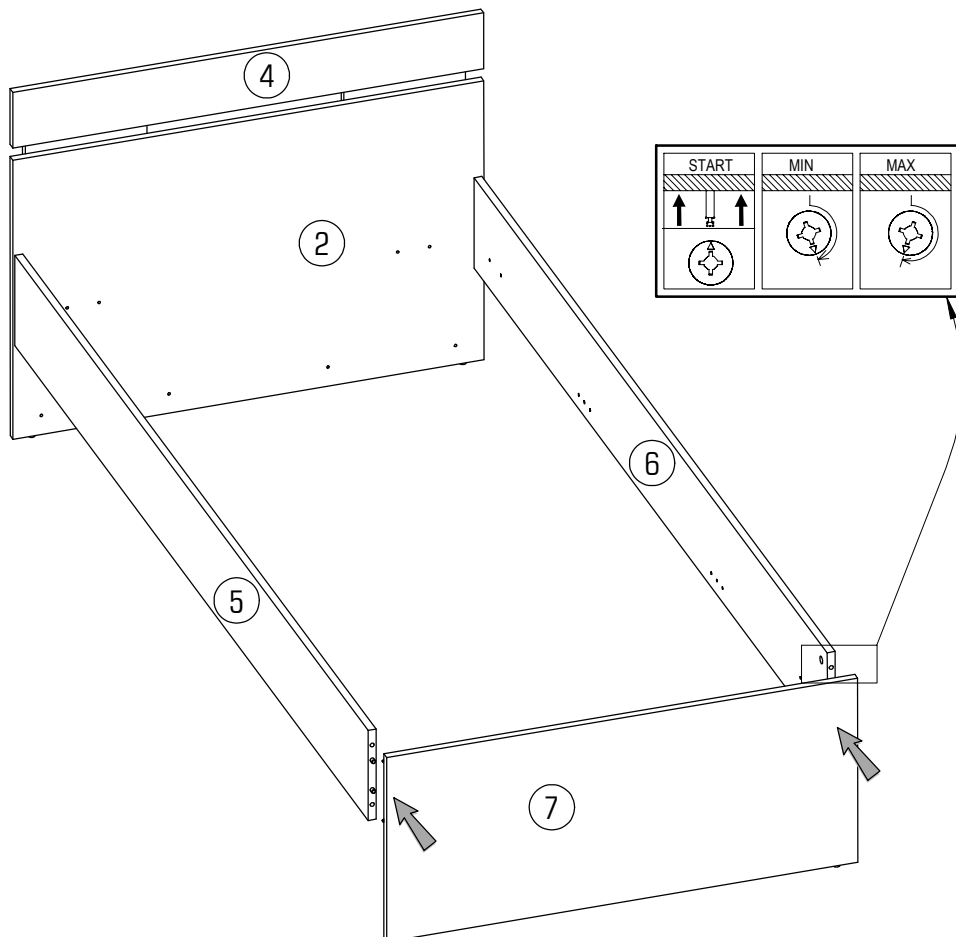
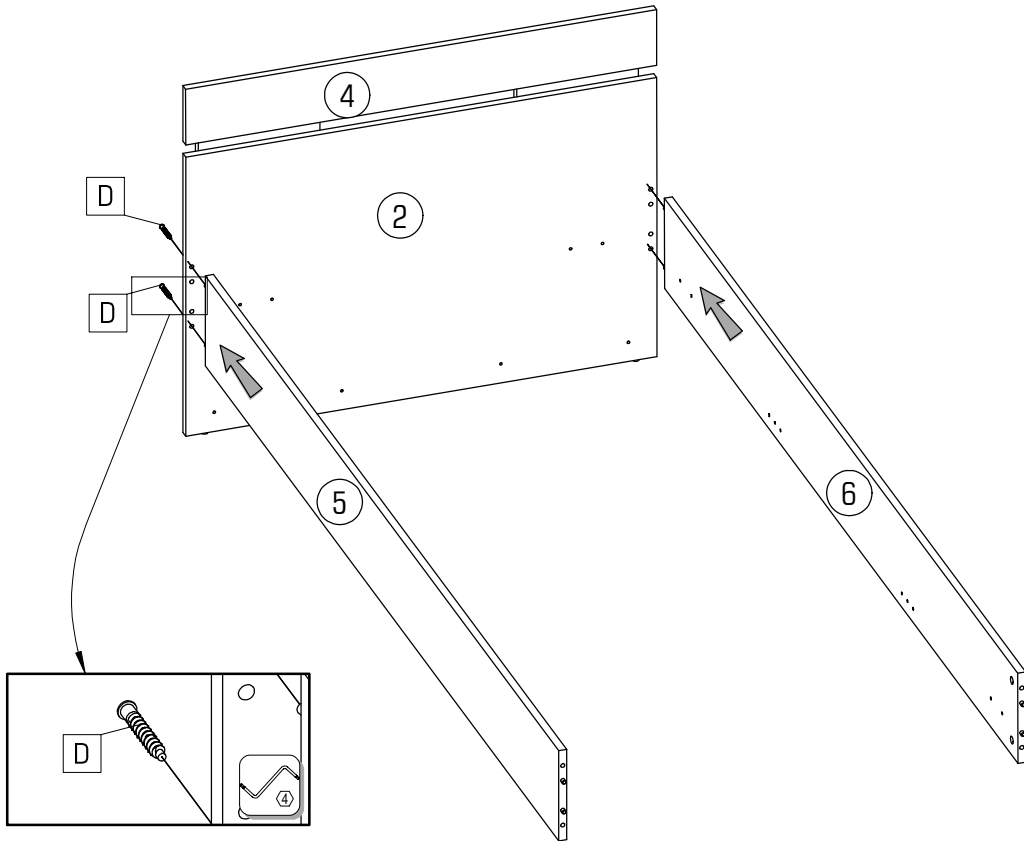
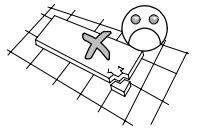
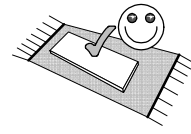
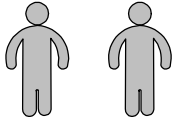

D

4x

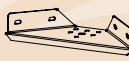

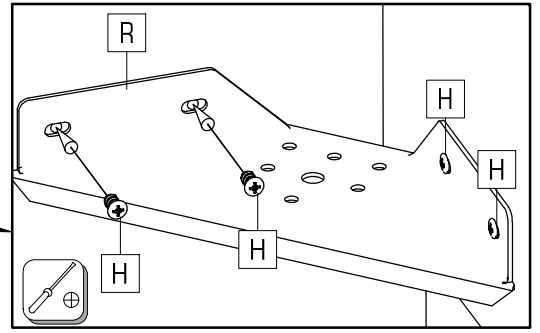
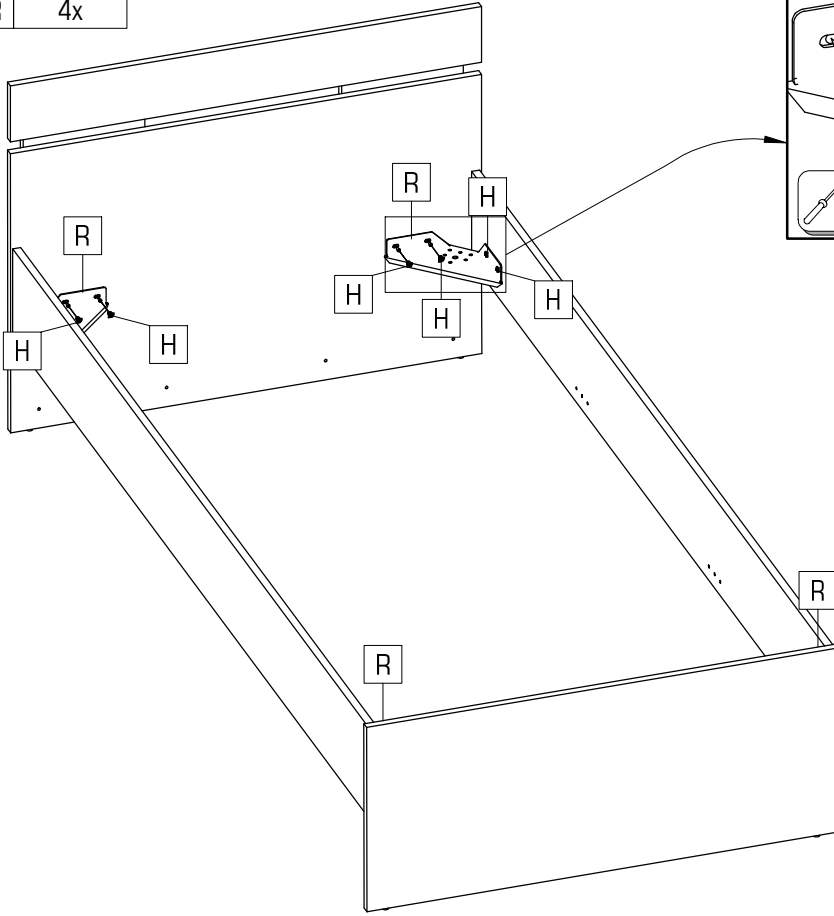







	$\varnothing 6,3 \times 11$		
H	16x	R	4x



	$\varnothing 6,8 \times 8$	
G	8x	
	$\varnothing 6,3 \times 11$	
H	16x	







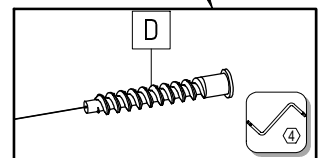
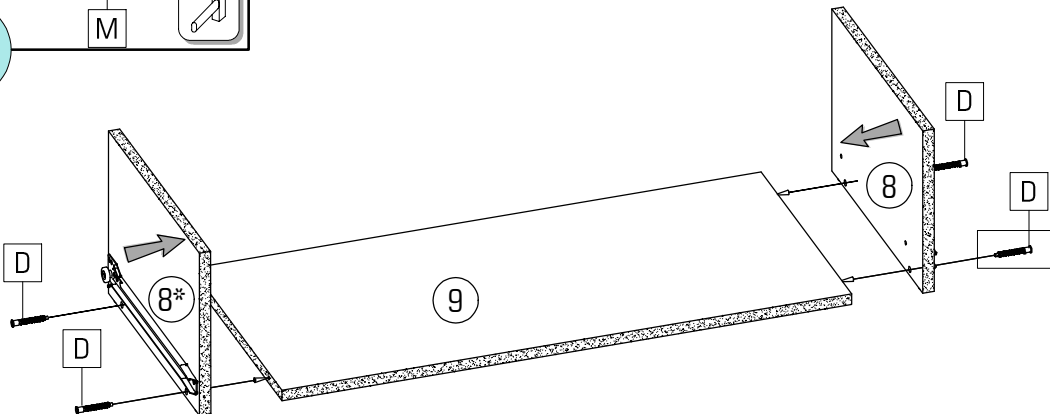
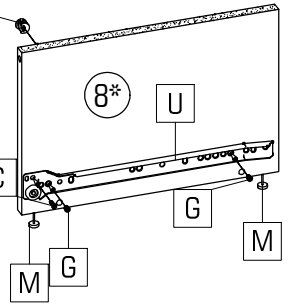
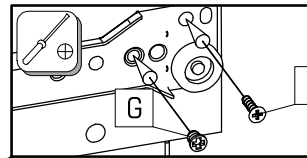
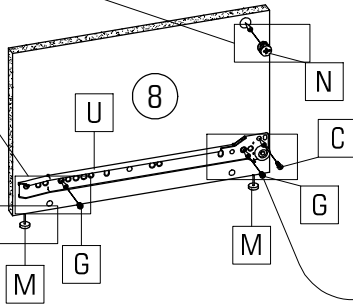
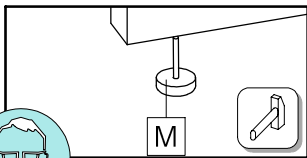
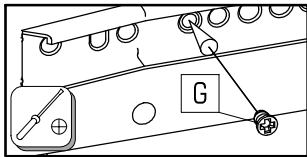
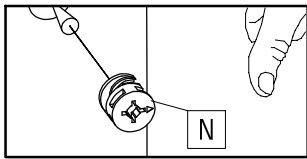

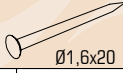
	$\varnothing 3,5 \times 15$		$\varnothing 7 \times 50$		$\varnothing 6,8 \times 8$				$\varnothing 15 \times 13$		L=350
C	2x	D	4x	G	4x	M	4x	N	2x	U	1x

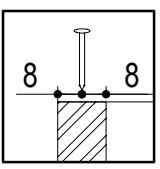
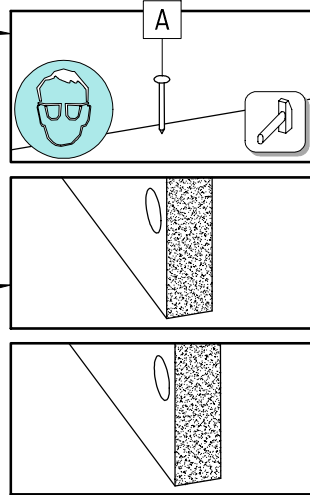
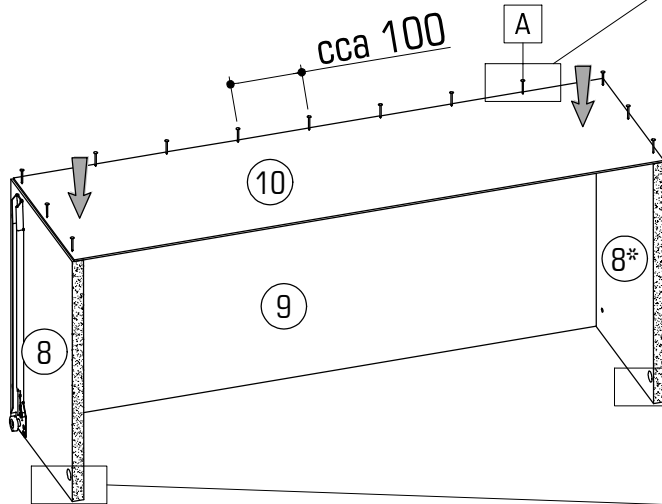
	$\varnothing 6,8 \times 8$		$\varnothing 6,3 \times 11$
G	8x	H	16x

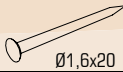
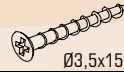
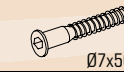

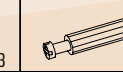



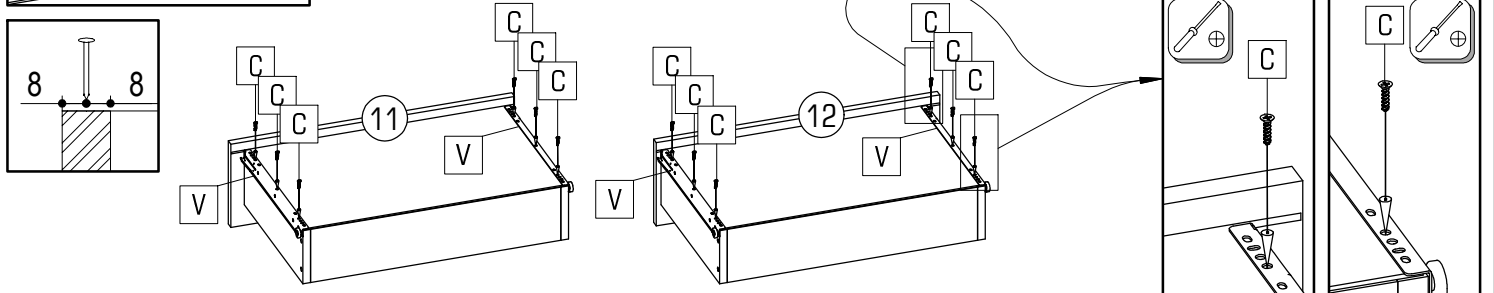
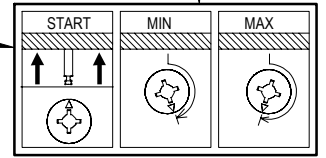
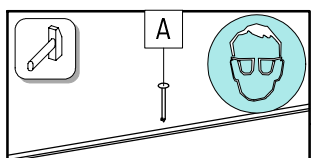
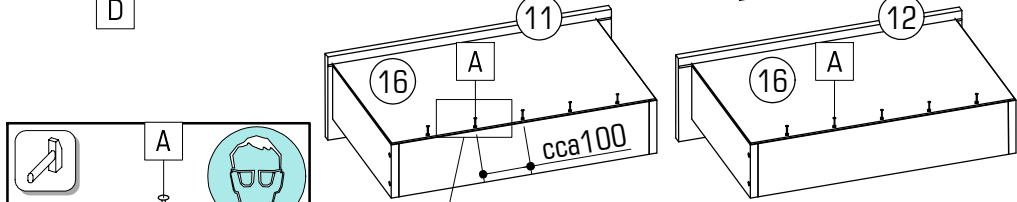
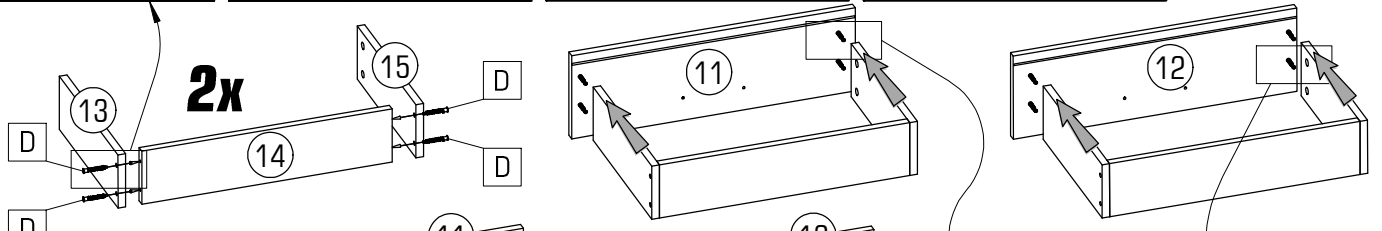
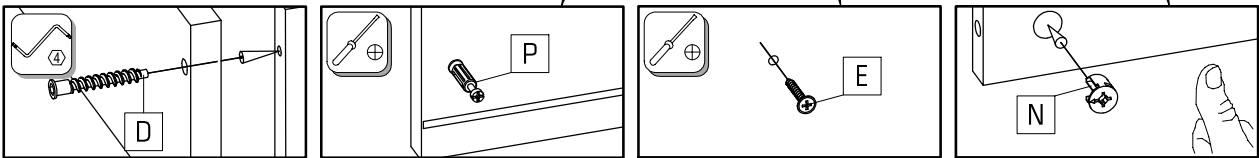
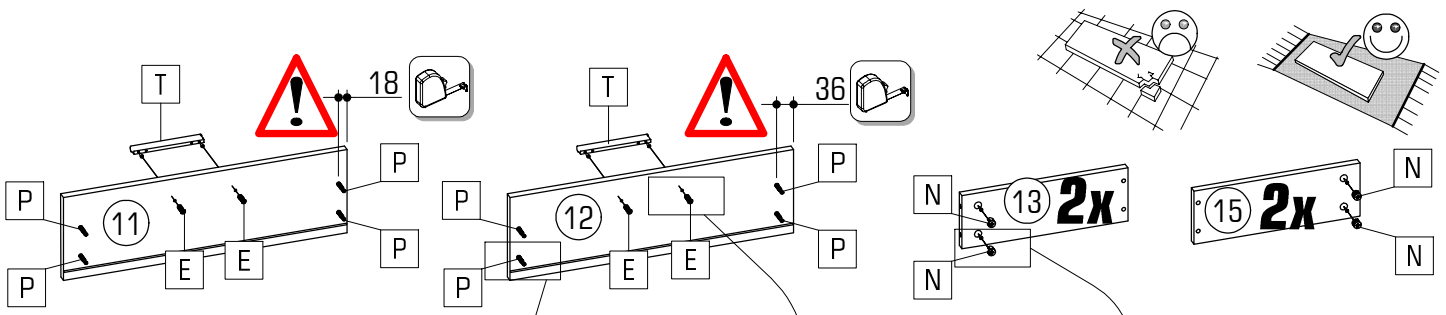

	Ø1,6x20
A	15x

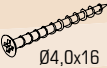
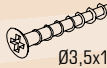

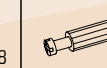
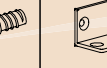





	Ø1,6x20		Ø3,5x15		Ø7x50		Ø4x25		Ø15x13						L=150		L=350
A	10x	C	12x	D	8x	E	4x	N	8x	P	8x	Q	8x	T	2x	V	2x

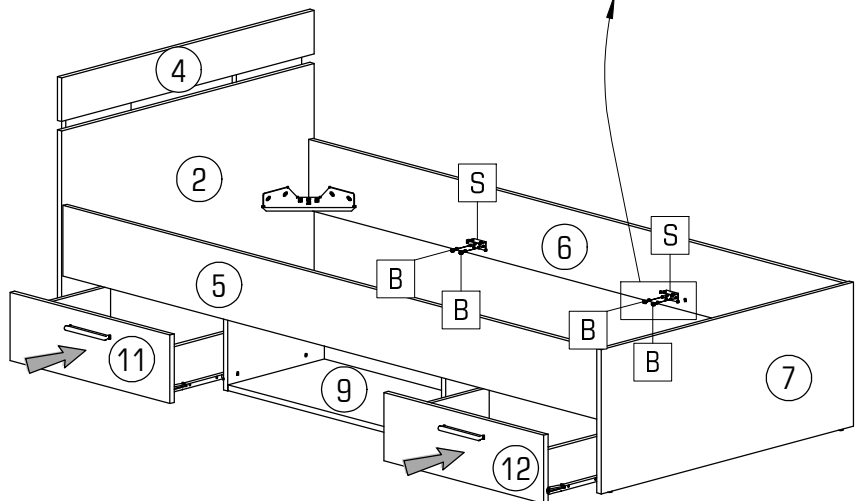
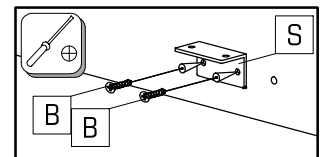
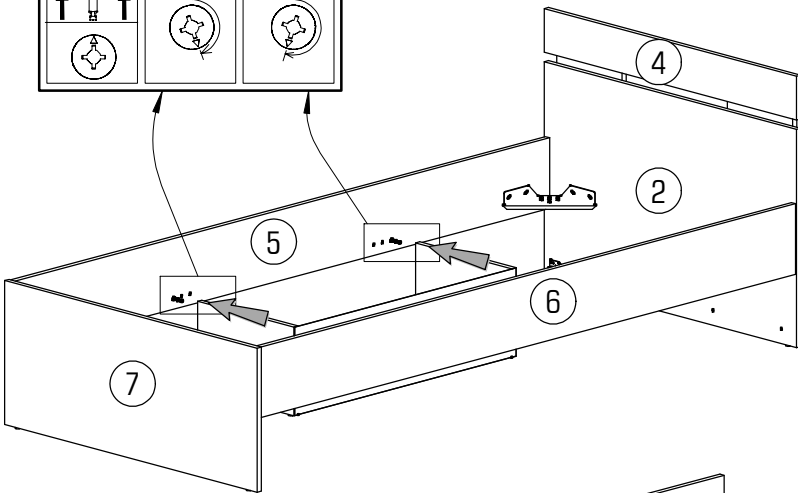
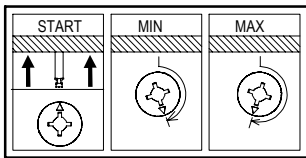
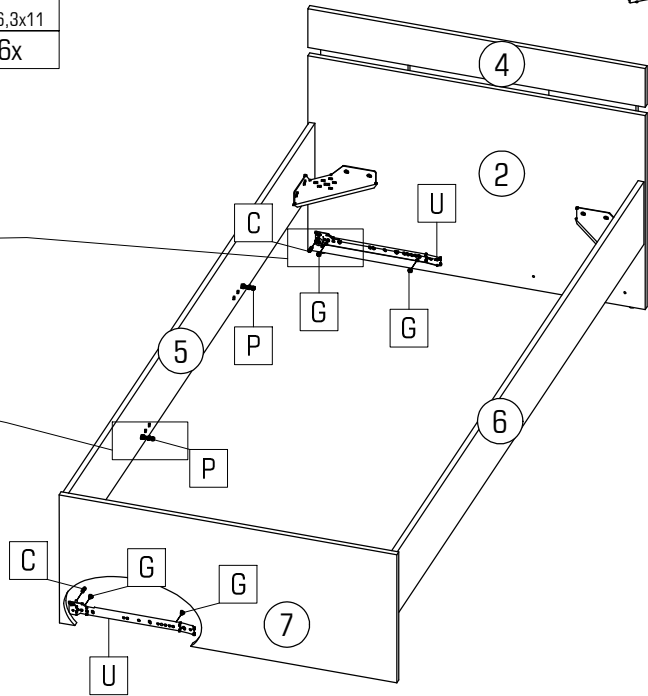
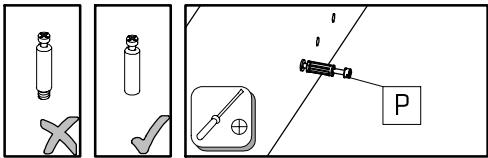
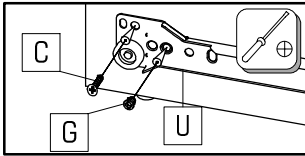
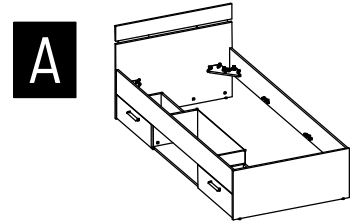

					
B	C	G	P	S	U
4x	2x	4x	2x	2x	1x

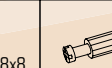

	
G	H
8x	16x

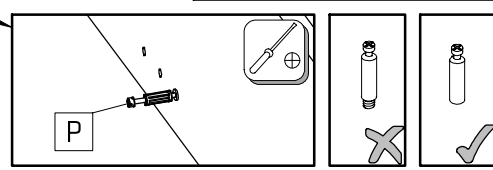
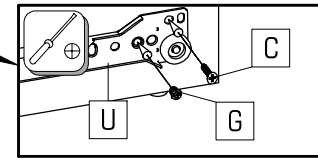
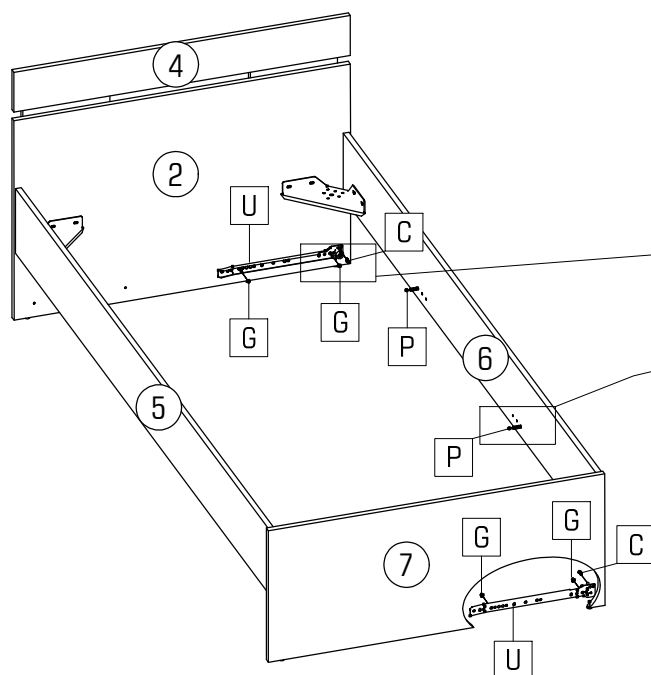
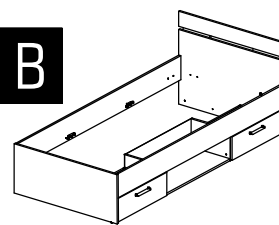

					
B 4x	C 2x	G 4x	P 2x	S 2x	U 1x

**B**



	
G 8x	H 16x

