

MICHIGIN 140

Art.-Nr.

338 754
338 755

↔	1445
↕	750
↗	2052
	mm

1/8
VO



	120 min			PZ2	4	0,5 kg	3m	600 mm

ID	ID	Image	Dimensions	Quantity	Notes
19255	②		1445*600*16	1x	2/2
19239	③		244*190*16	2x	1/2 2/2
19256	④		1445*120*16	1x	2/2
19241	⑤		2004*194*16	1x	1/2
19242	⑥		2004*194*16	1x	1/2
19258	⑦		2004*244*16	1x	1/2
19257	⑧		1445*396*16	1x	2/2
19244	⑨		244*361*16	2x	1/2
19245	⑩		800*360*16	1x	2/2
19246	⑪		828*242*3	1x	2/2
19247	⑫		598*188*16	1x	2/2
19248	⑬		598*188*16	1x	2/2
19025	⑭		350*120*16	2x	2/2
19249	⑮		528*120*16	2x	2/2
19027	⑯		350*120*16	2x	2/2
19250	⑰		556*356*3	2x	2/2



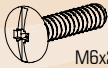

A **2x 100 kg** **B**

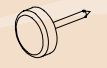
21102,00	22232,00	22243,00	22300,00	22430,00	22453,00	22705,00	22707,00
A 25x	B 4x	C 16x	D 18x	E 4x	F 8x	G 8x	H 16x
22800,01	24091,00	27000,00	30091,00	70013,01	70021,01		31106,00
J 1x	K 8x	L 12x	M 14x	N 16x	P 16x	Q 8x	R 4x
31108,01	32030,00	33006,01	33006,01				
S 2x	T 2x	U 2x	V 2x				

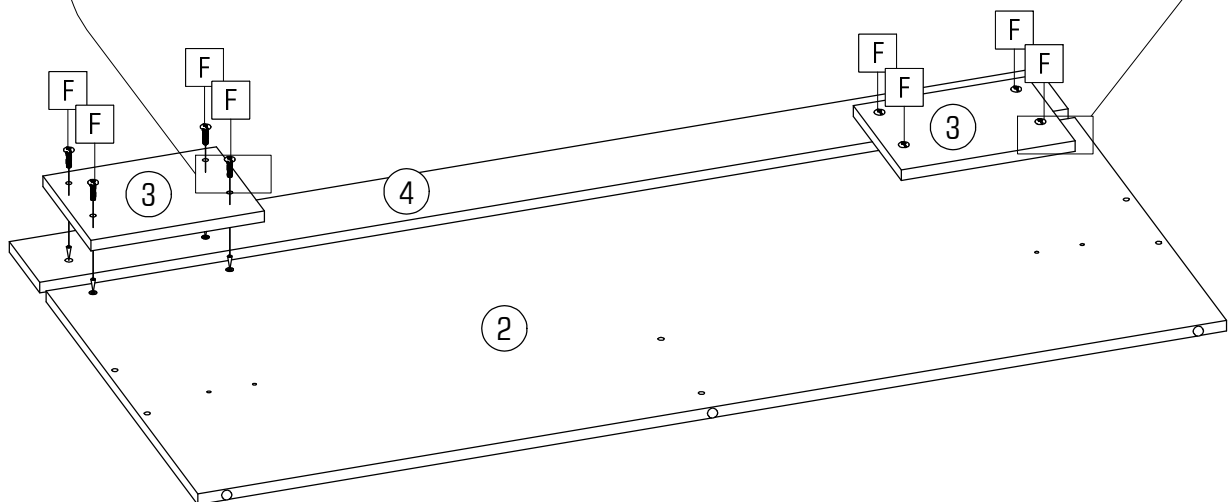
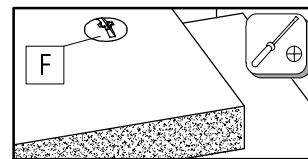
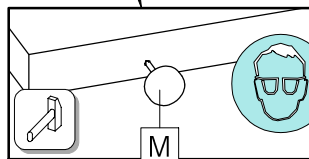
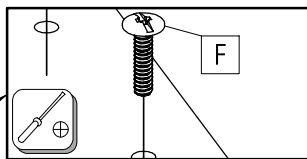
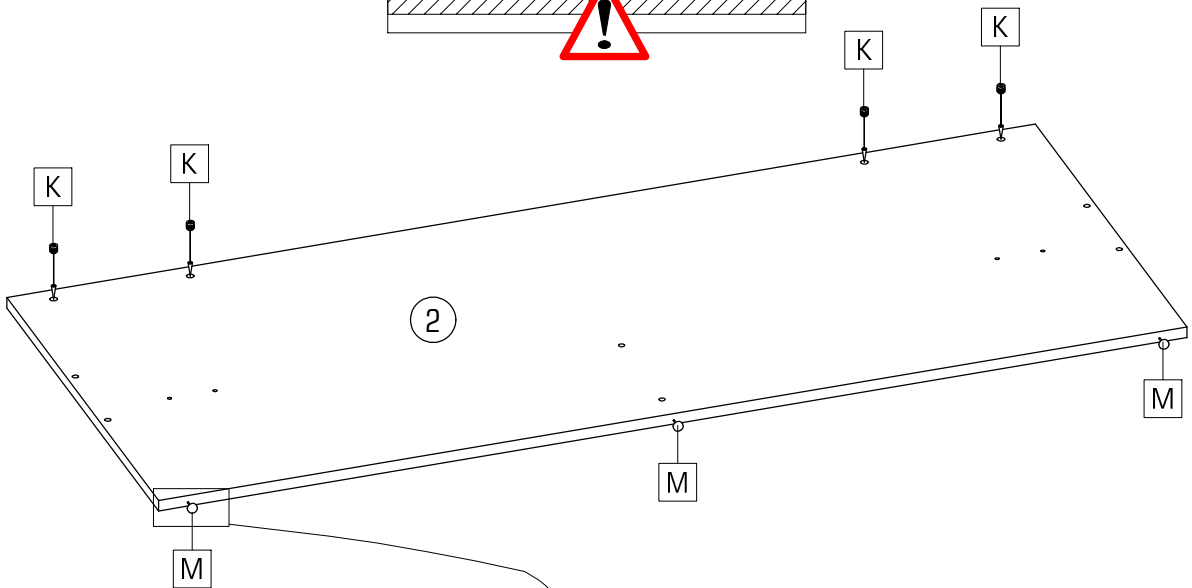
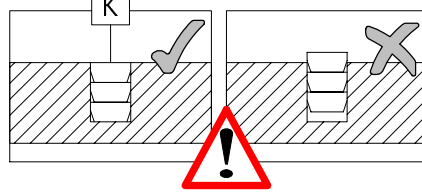
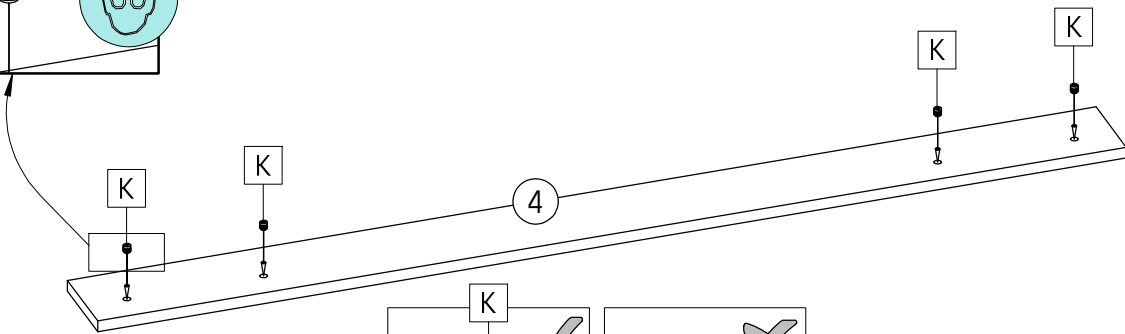
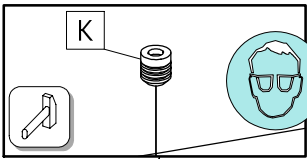
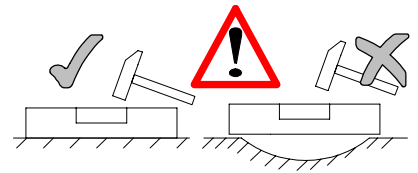
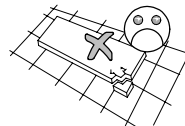
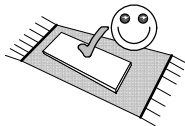
X	✓	X	✓	X	✓	X	X	X	✓

		
M6x25	Ø10x11	
F 8x	K 8x	M 3x



			
L 12x	M 7x	N 6x	P 6x

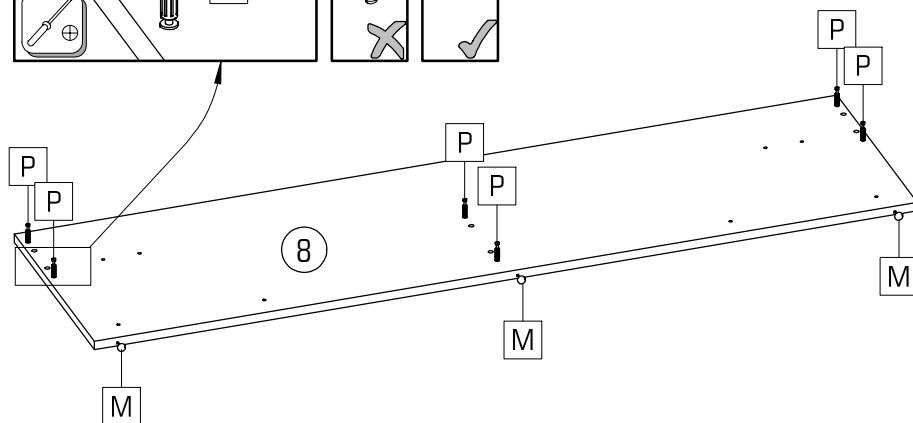
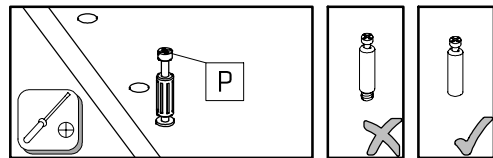
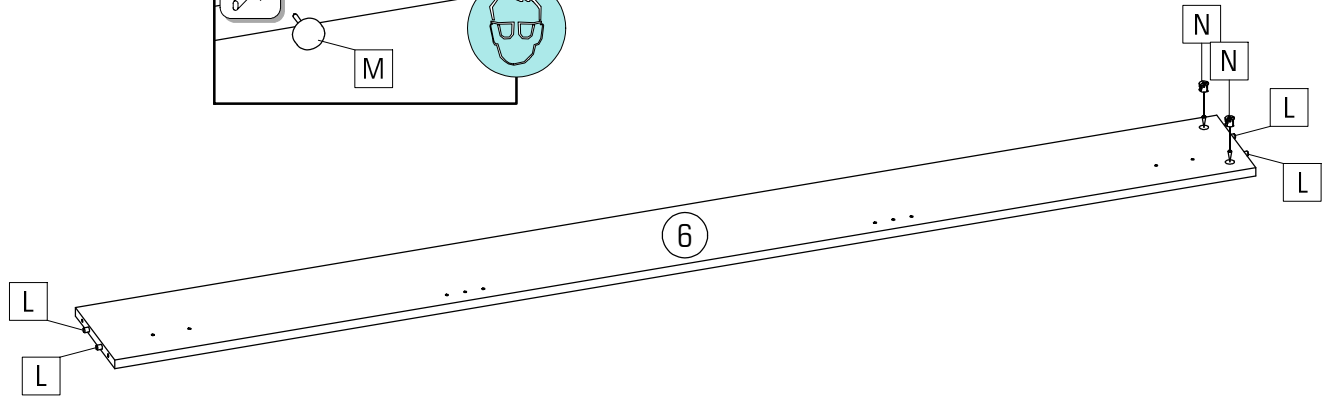
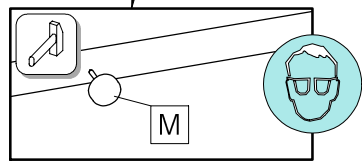
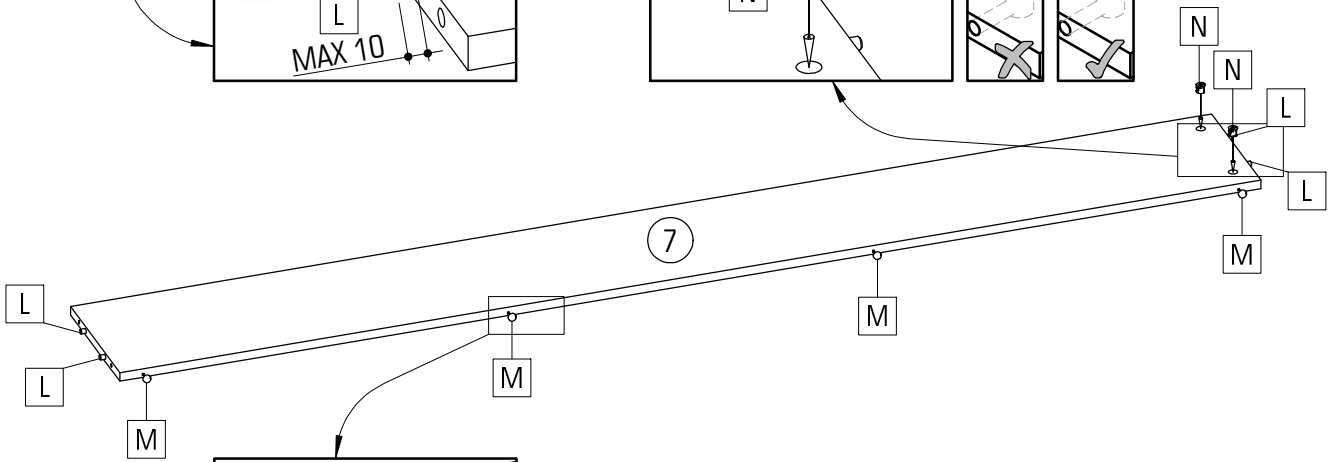
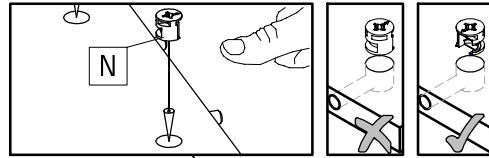
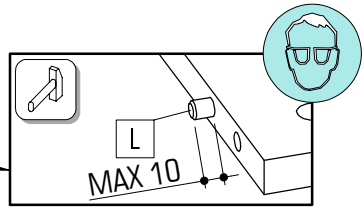
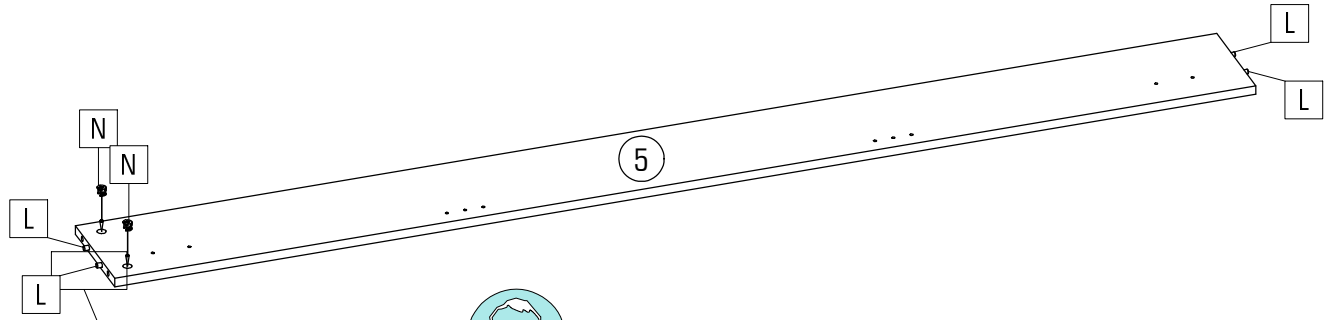
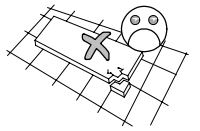
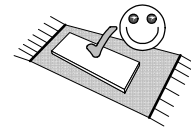





Ø7x50

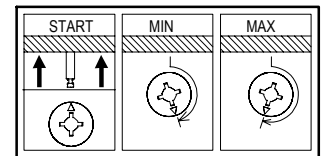
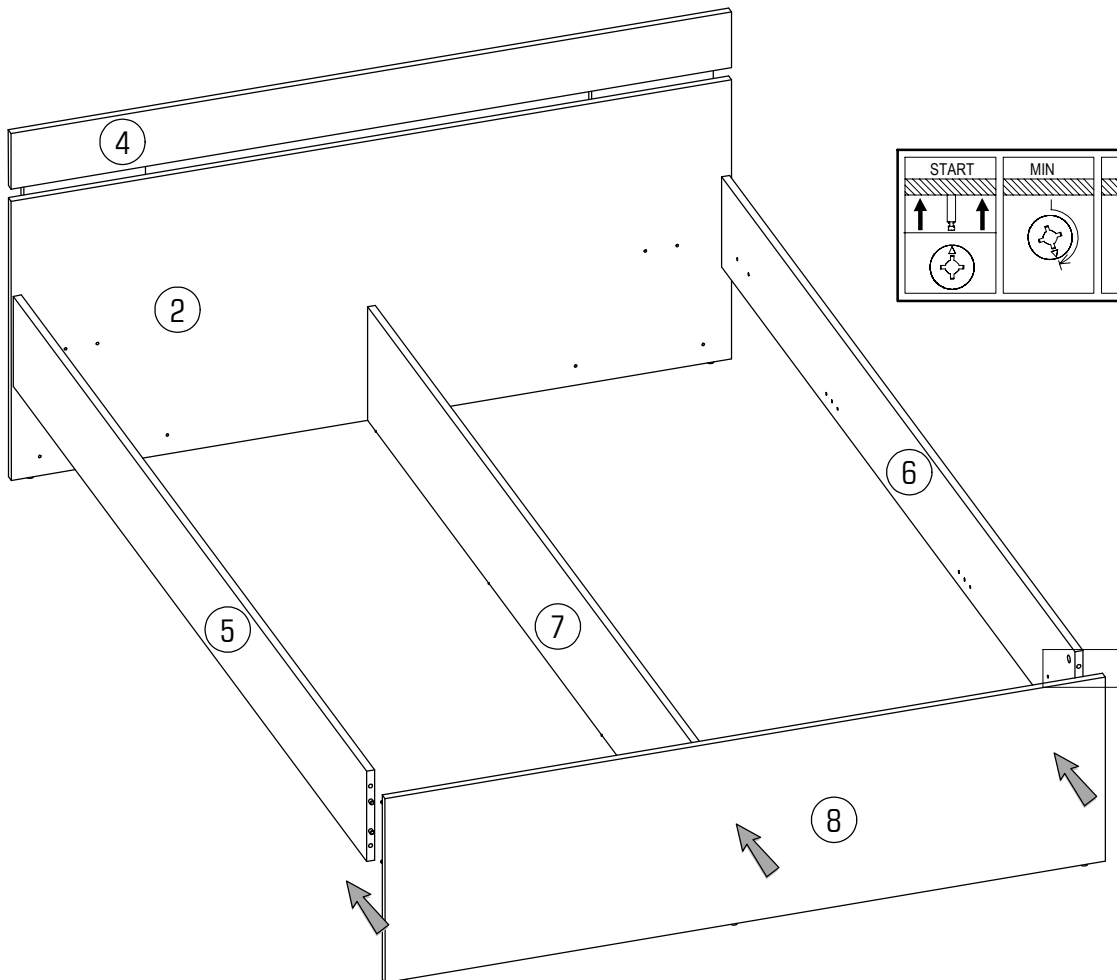
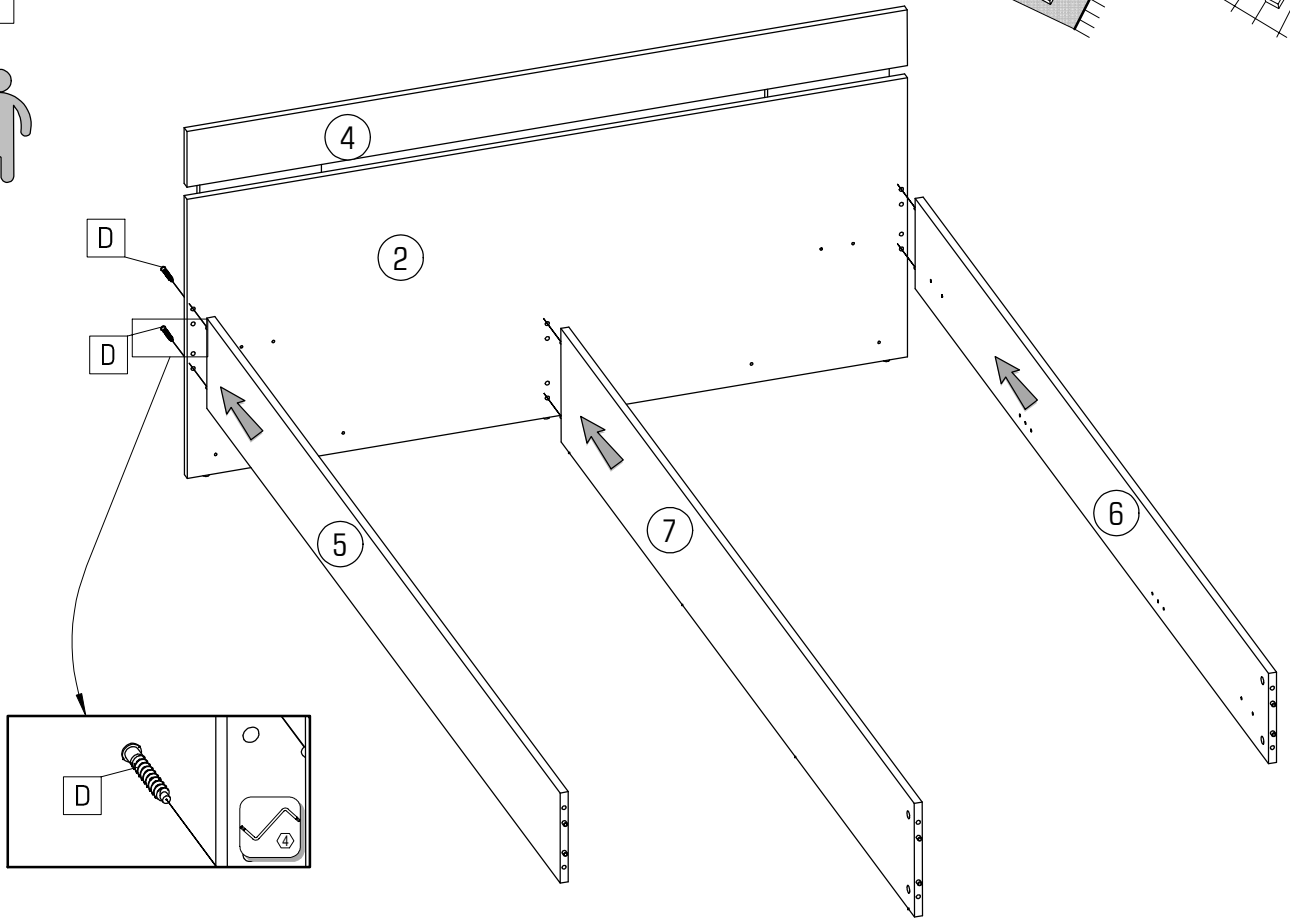
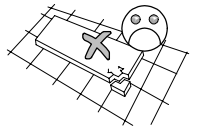
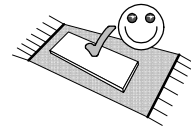
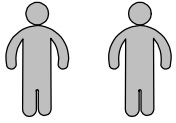

D

6x

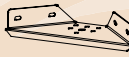

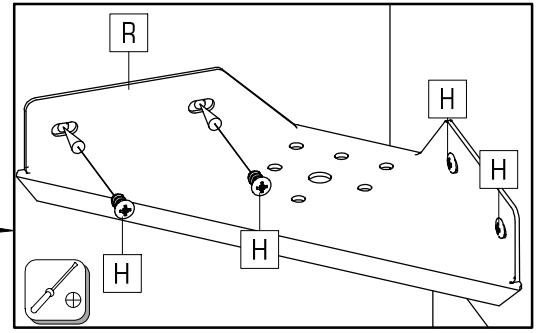
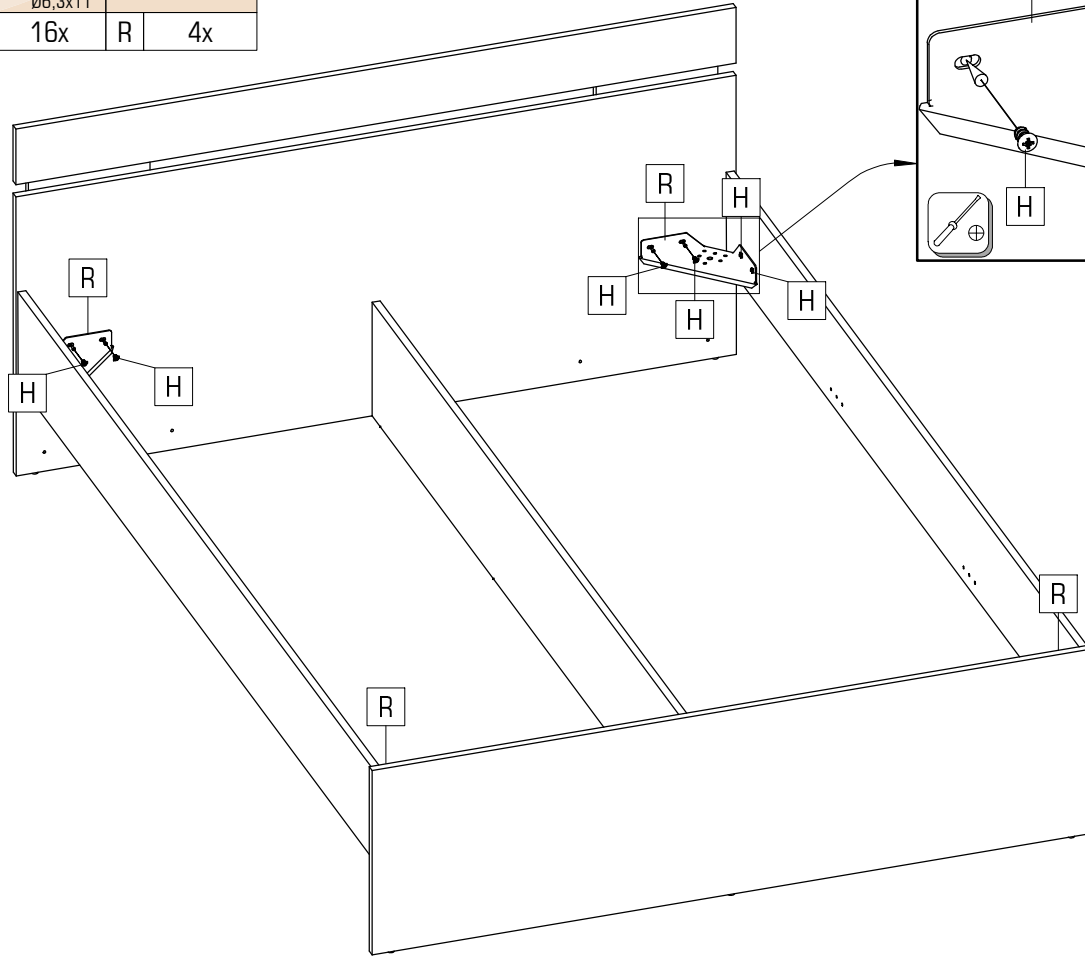





	$\varnothing 6,3 \times 11$		
H	16x	R	4x

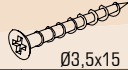

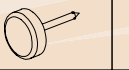

	$\varnothing 6,8 \times 8$		
G	8x		
	$\varnothing 6,3 \times 11$		
H	16x		





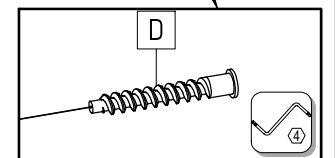
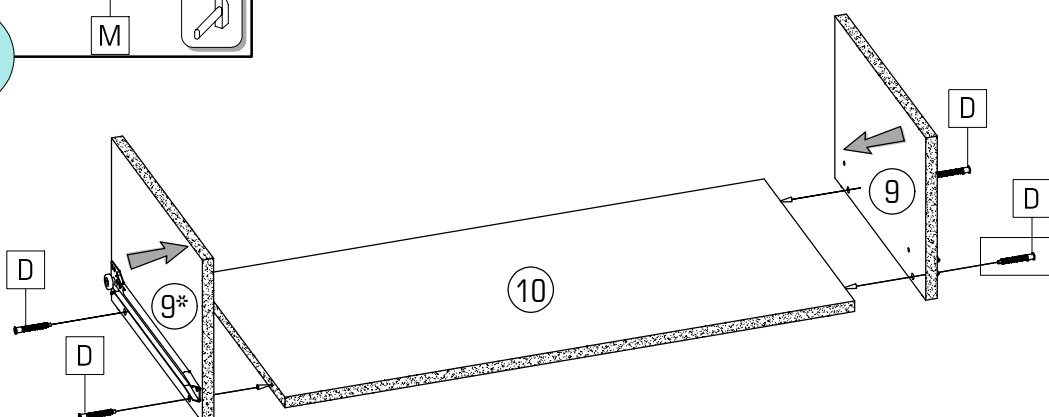
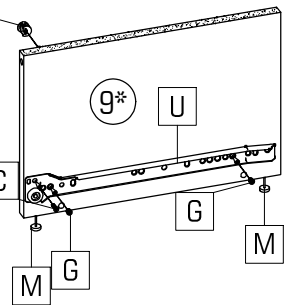
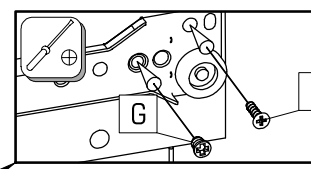
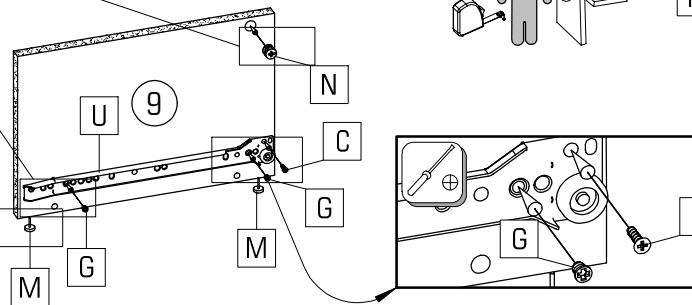
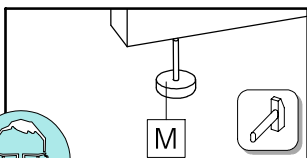
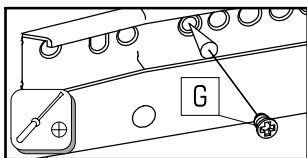
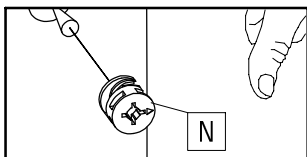



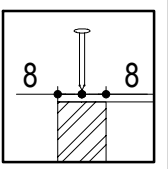
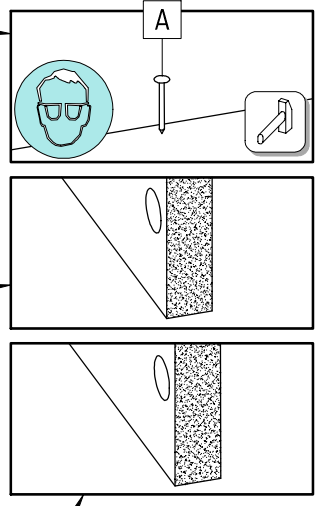
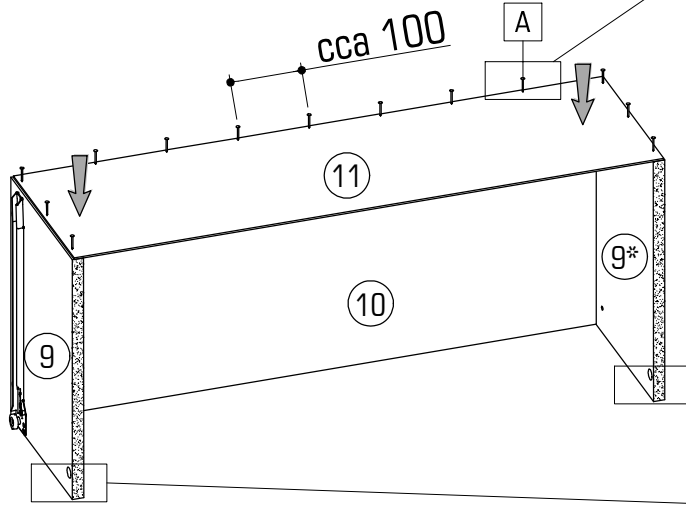

	$\varnothing 3,5 \times 15$		$\varnothing 7 \times 50$		$\varnothing 6,8 \times 8$			$\varnothing 15 \times 13$		L=350	
C	2x	D	4x	G	4x	M	4x	N	2x	U	1x

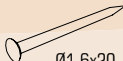
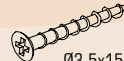
	$\varnothing 6,8 \times 8$		$\varnothing 6,3 \times 11$
G	8x	H	16x



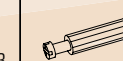



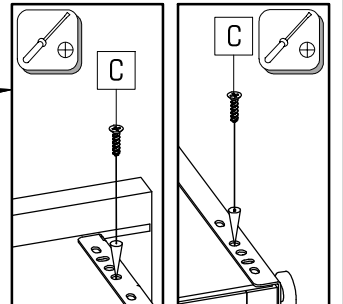
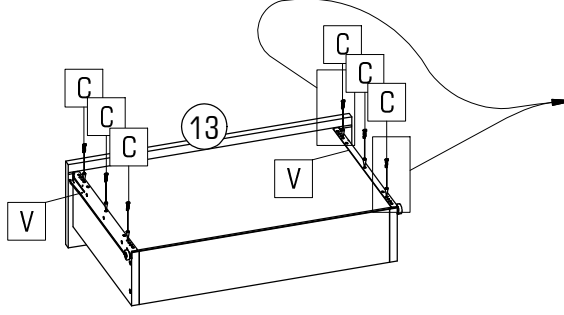
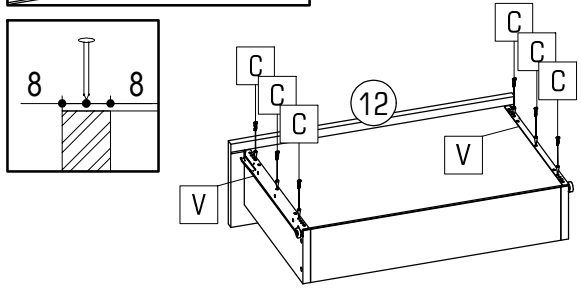
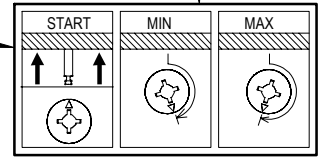
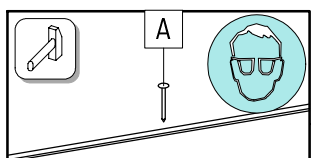
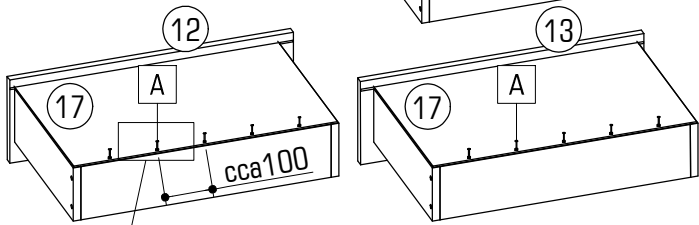
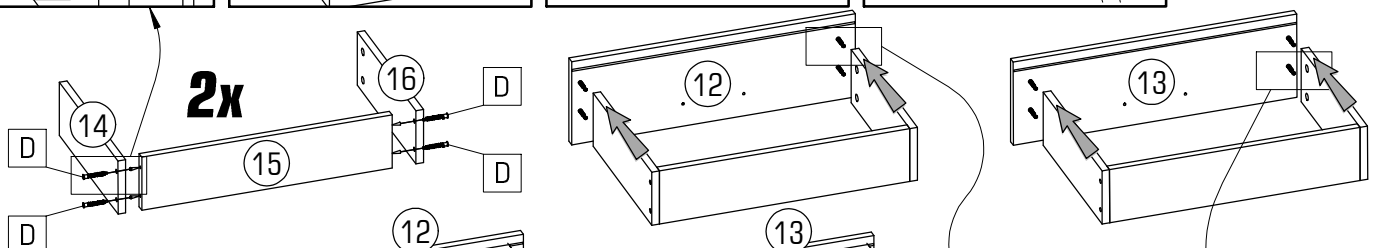
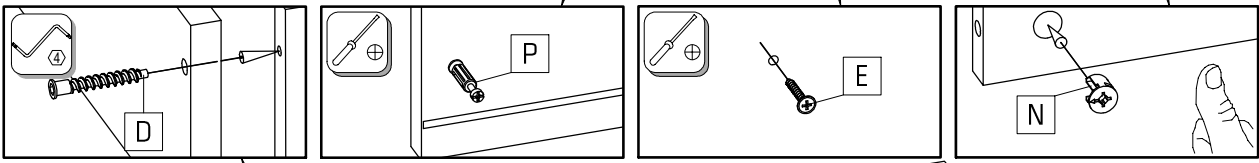
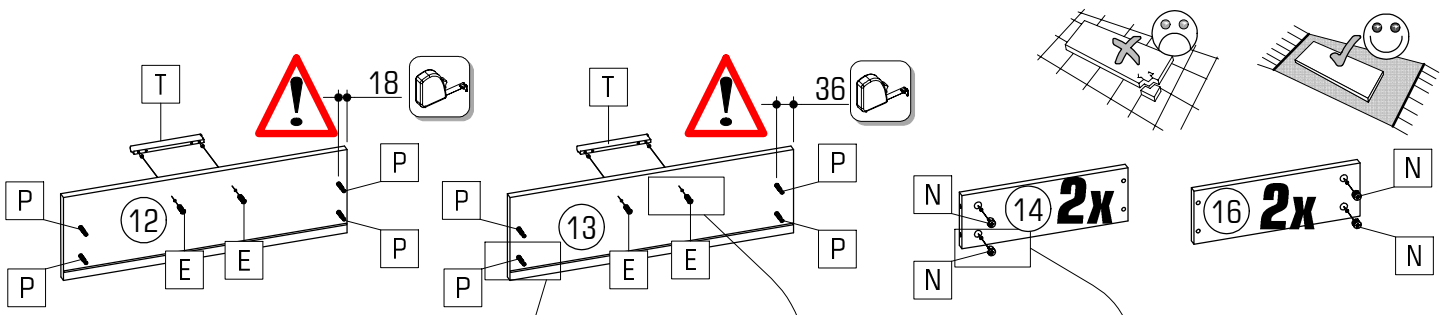

	Ø1,6x20
A	15x

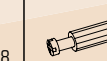

	Ø1,6x20		Ø3,5x15		Ø7x50		Ø4x25		Ø15x13						L=150		L=350
A	10x	C	12x	D	8x	E	4x	N	8x	P	8x	Q	8x	T	2x	V	2x







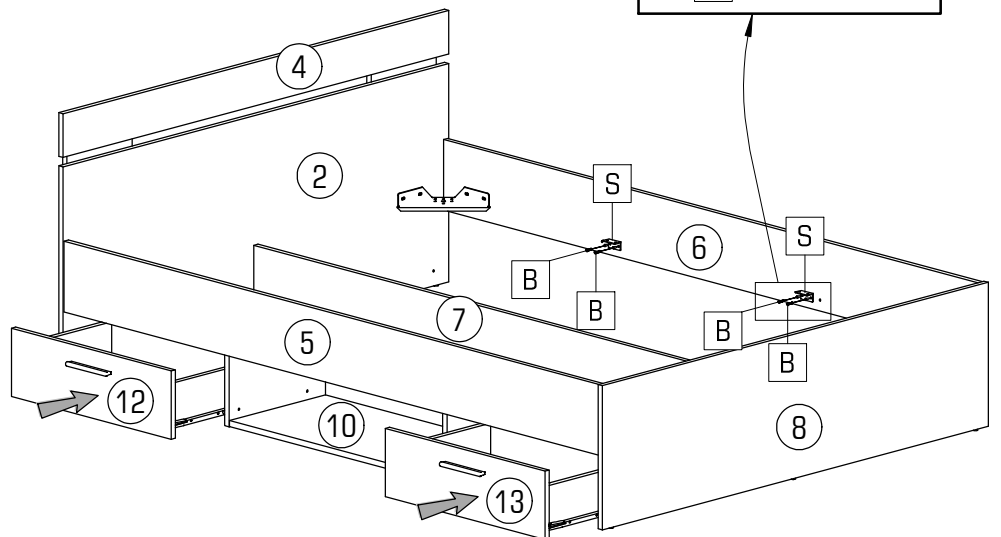
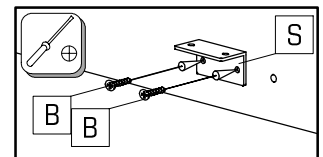
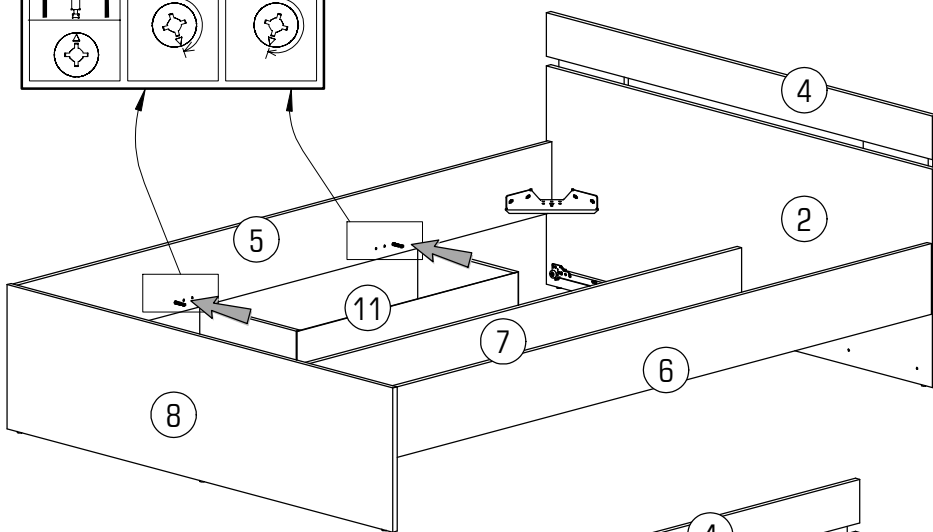
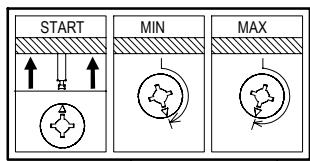
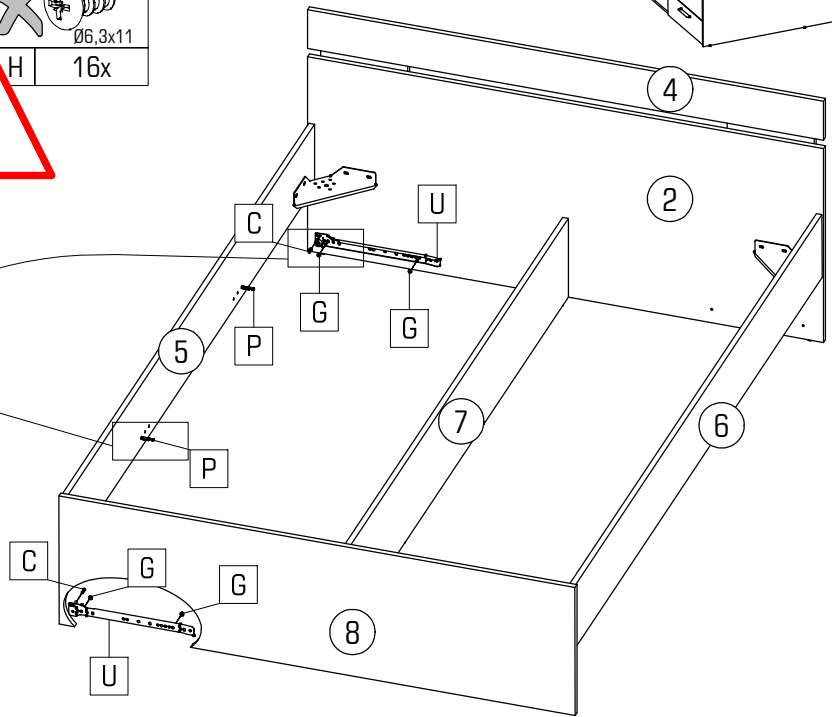
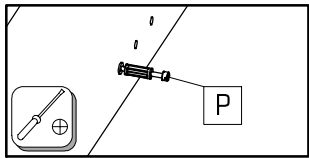
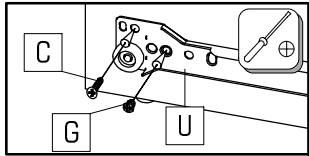
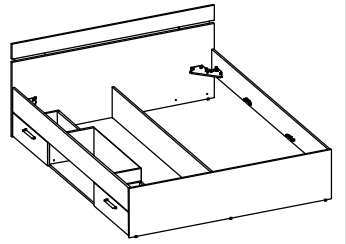

					
B	C	G	P	S	U
4x	2x	4x	2x	2x	1x

	
G	H
8x	16x



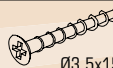

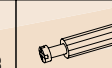
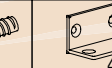
A

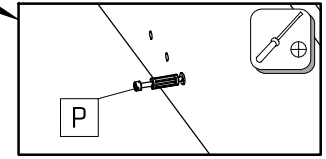
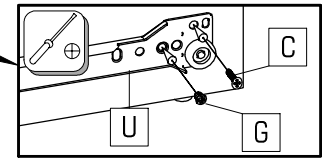
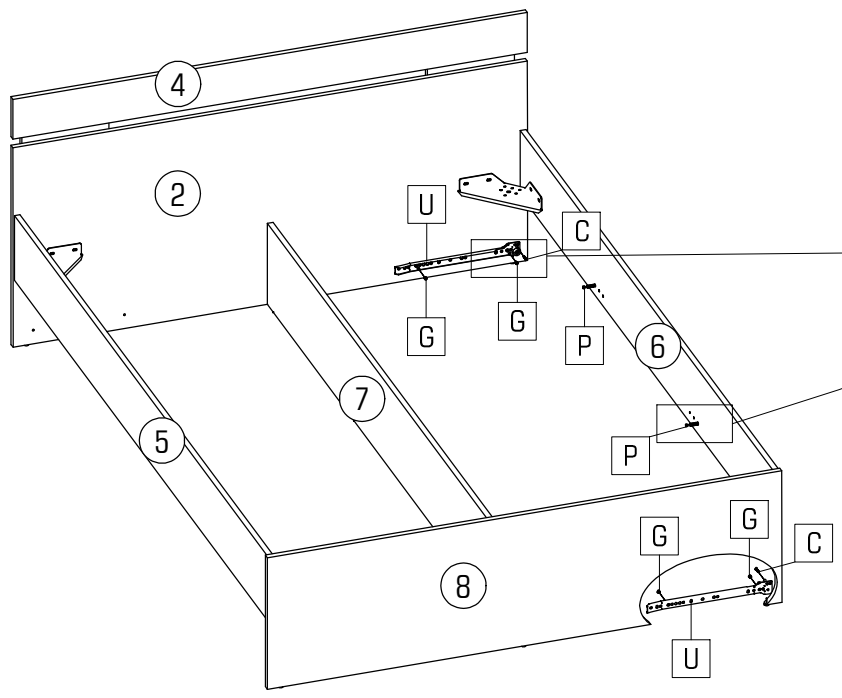
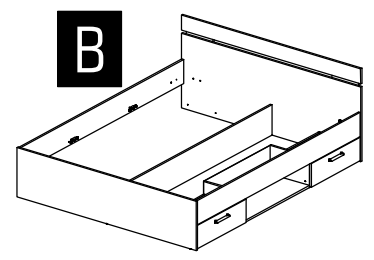

					
B 4x	C 2x	G 4x	P 2x	S 2x	U 1x
<small>Ø4,0x16</small>	<small>Ø3,5x15</small>	<small>Ø6,8x8</small>		<small>44x23x23</small>	<small>L=350</small>

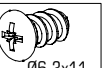

			
G 8x	<small>Ø6,8x8</small>	H 16x	<small>Ø6,3x11</small>

