

LUVONUT

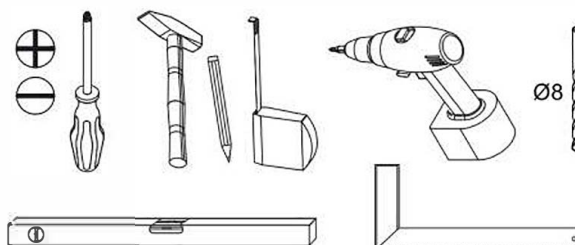

CZ Povrch nábytku čistěte pouze přípravky určenými k ošetřování nábytku.

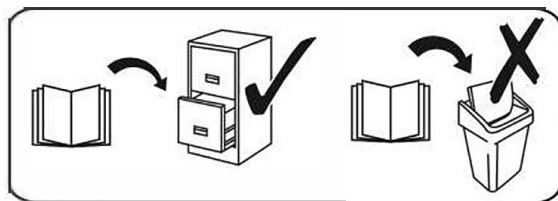

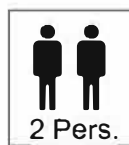
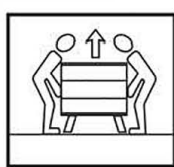
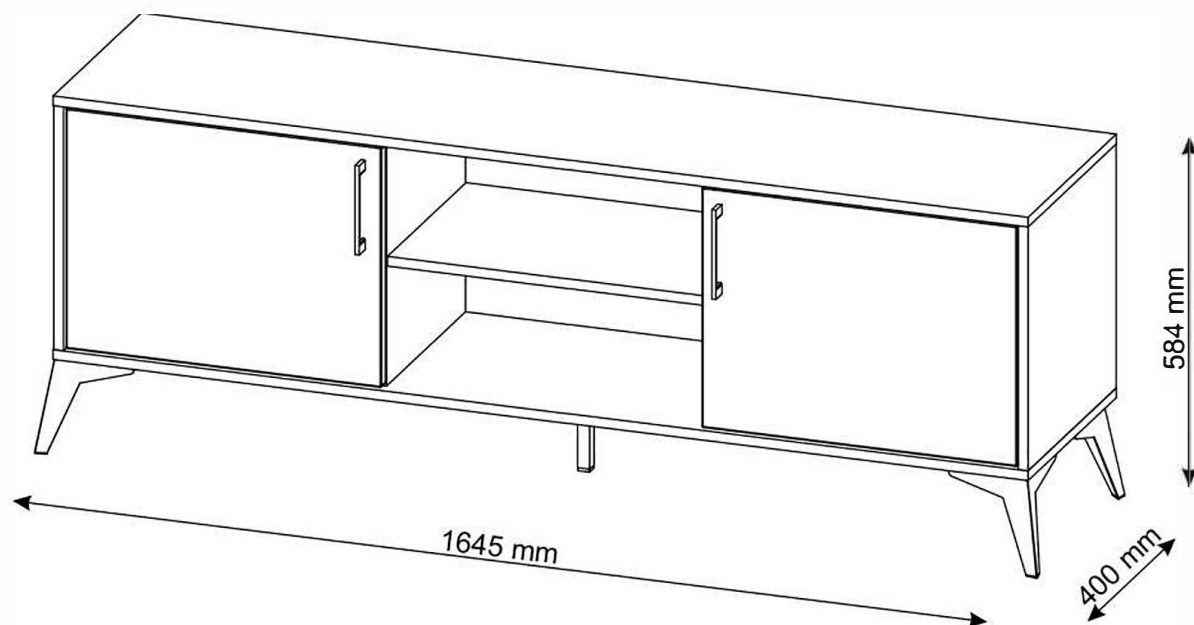







SK Povrch nábytku čistite iba prostriedkami určenými na ošetrovanie nábytku.





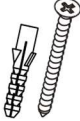

RO Suprafata ei trebuie să fie curătată numai cu substanțe destinate pentru curățarea mobilei.

HU A bútor felületét csak bútorápoló szerekkel szabad tisztítani.

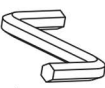
HR Površinu namještaja treba čistiti samo sredstvima za njegu namještaja.

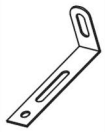
SI Površino pohištva čistite samo s sredstvi za nego pohištva.

A0	B1	B4	C2	C4	C7	D4	D5	E0	H2	J5
										
Ø8x30	Ø7x50				16 mm	3.5x16	3.5x16	8x50	4x22	
x16	x8	x4	x8	x8	x8	x24	x28	x2	x4	x4

K	L15	M1	P0	Q0	T7	T20
						
4mm						
x1	x2	x16	x2	x4	x1	x4

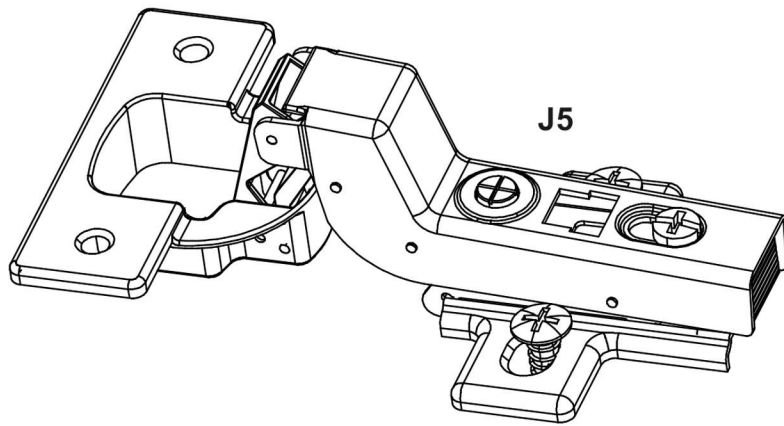

3.5x16



D5

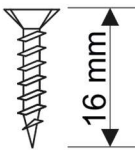

3.5x16



D4

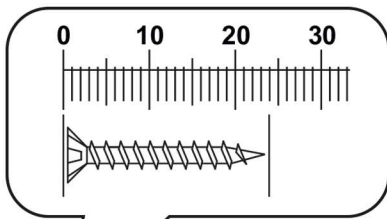
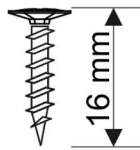

①	1605	400	16 x1	2/2
②	1605	400	16 x1	2/2
③	521	355	16 x1	1/2
④	402	399	16 x1	1/2
⑤	402	399	16 x1	1/2
⑥	402	358	16 x1	1/2
⑦	402	358	16 x1	1/2
⑧	396	520	18 x1	1/2
⑨	396	520	18 x1	1/2
⑩	412	522	3 x1	1/2
⑪	412	537	3 x1	1/2
				1/2

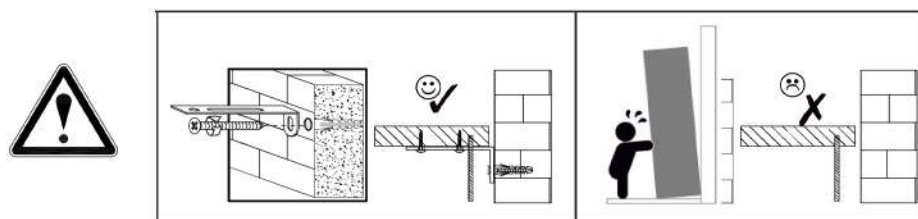
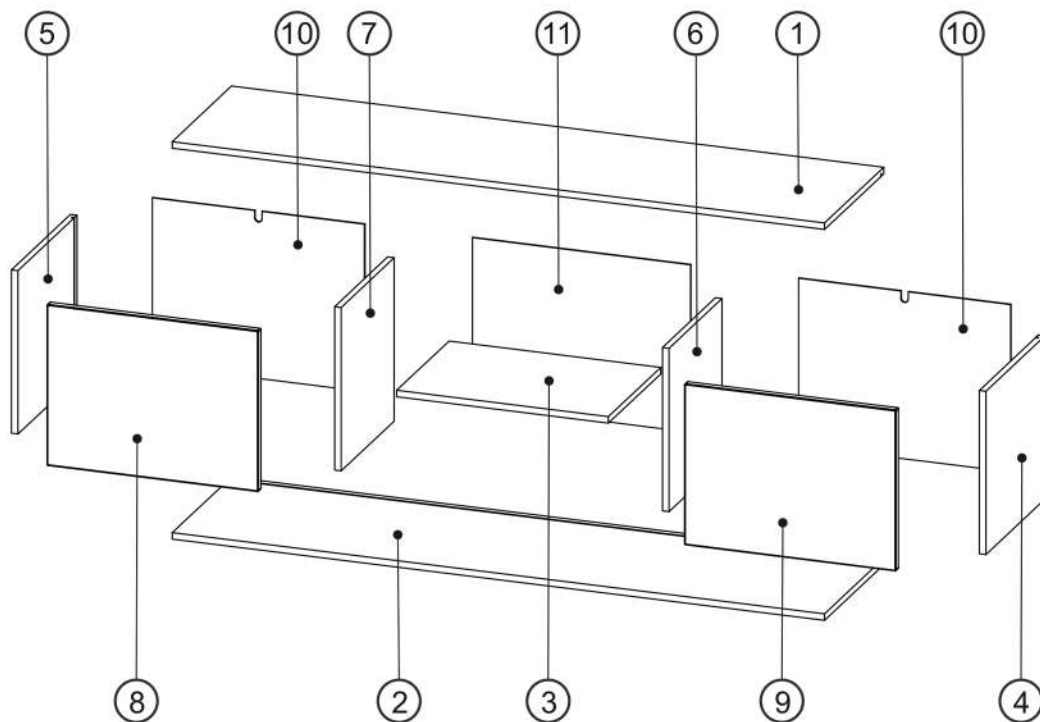

CZ Připevnění ke stěně

Prosím, nesbírejte nábytek, pokud jsou jeho prvky poškozené. Před montáží je nutné pečlivě prohlédnout jednotlivé prvky nábytku. V případě jejich poškození je třeba je nahlásit spolu s fotodokumentací pro posouzení reklamace a přijetí vhodných opatření.

SK Pripevnenie na stenu

Prosím, nezberajte nábytok, ak sú jeho prvky poškodené. Pred montážou je potrebné dôkladne prezrieť jednotlivé prvky nábytku. V prípade ich poškodenia je potrebné nahlásiť ich spolu s fotodokumentáciou pre posúdenie reklamácie a prijatie nábytku. V prípade ich poškodenia je potrebné nahlásiť ich spolu s fotodokumentáciou pre posúdenie reklamácie a prijatie vhodných opatrení.

RO Atașați la perete

Vă rugăm să nu colectați mobilier dacă elementele acesteia sunt deteriorate. Înainte de asamblare, este necesar să inspectați cu atenție elementele individuale ale mobilierului. În caz de deteriorare a acestora, trebuie raportat împreună cu documentația foto pentru a lua în considerare reclamația și a lua măsurile corespunzătoare.

HU A falhoz rögzítés

Kérjük, ne gyűjtse össze a bútort, ha azok elemei sérültek. Összeszerelés előtt alaposan meg kell vizsgálni a bűtor egyes elemeit. Ha megsérülnek, fényképes dokumentációval együtt be kell jelenteni a panasz mérlegelésére és a megfelelő intézkedések megtételére.

HR Montaža na zid



Molimo nemojte skupljati namještaj ako su njegovi dijelovi oštećeni. Prije montaže potrebno je pažljivo pregledati pojedine elemente namještaja. U slučaju oštećenja iste potrebno je prijaviti uz fotodokumentaciju kako bi se reklamacija razmotrila i poduzele odgovarajuće mjere.

SI Pritrdite na steno

Ne zbirajte pohištva, če so njegovi elementi poškodovani. Pred montažo je potrebno natančno pregledati posamezne elemente pohištva. V primeru poškodb le-teh je potrebno prijaviti skupaj s fotodokumentacijo, da se reklamacija obravnava in ustrezno ukrepa.

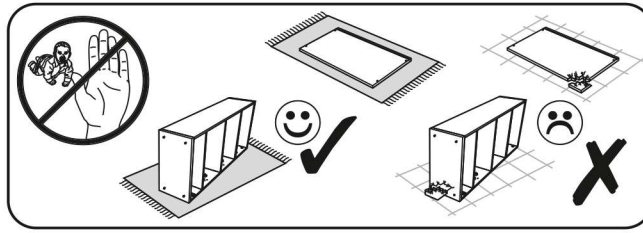
1



A0  Ø8x30 x16	C2  x8	C7  16 mm x8
-------------------------------------------------------------------------------------------------------------------------	---------------------------------------------------------------------------------------------------------------	------------------------------------------------------------------------------------------------------------------------

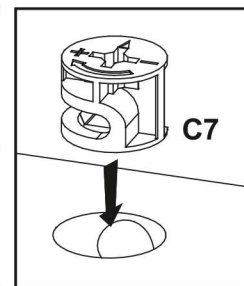
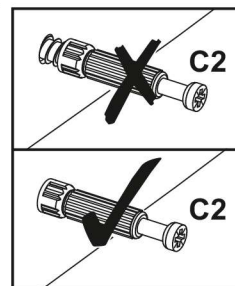
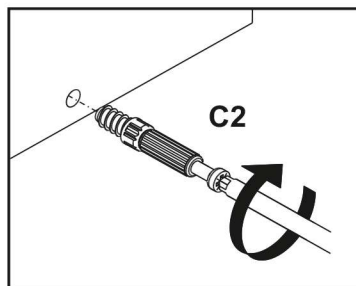
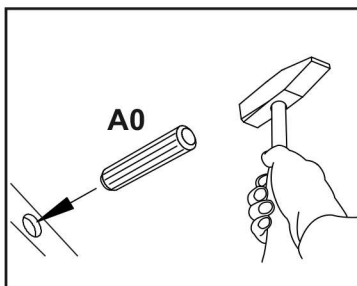
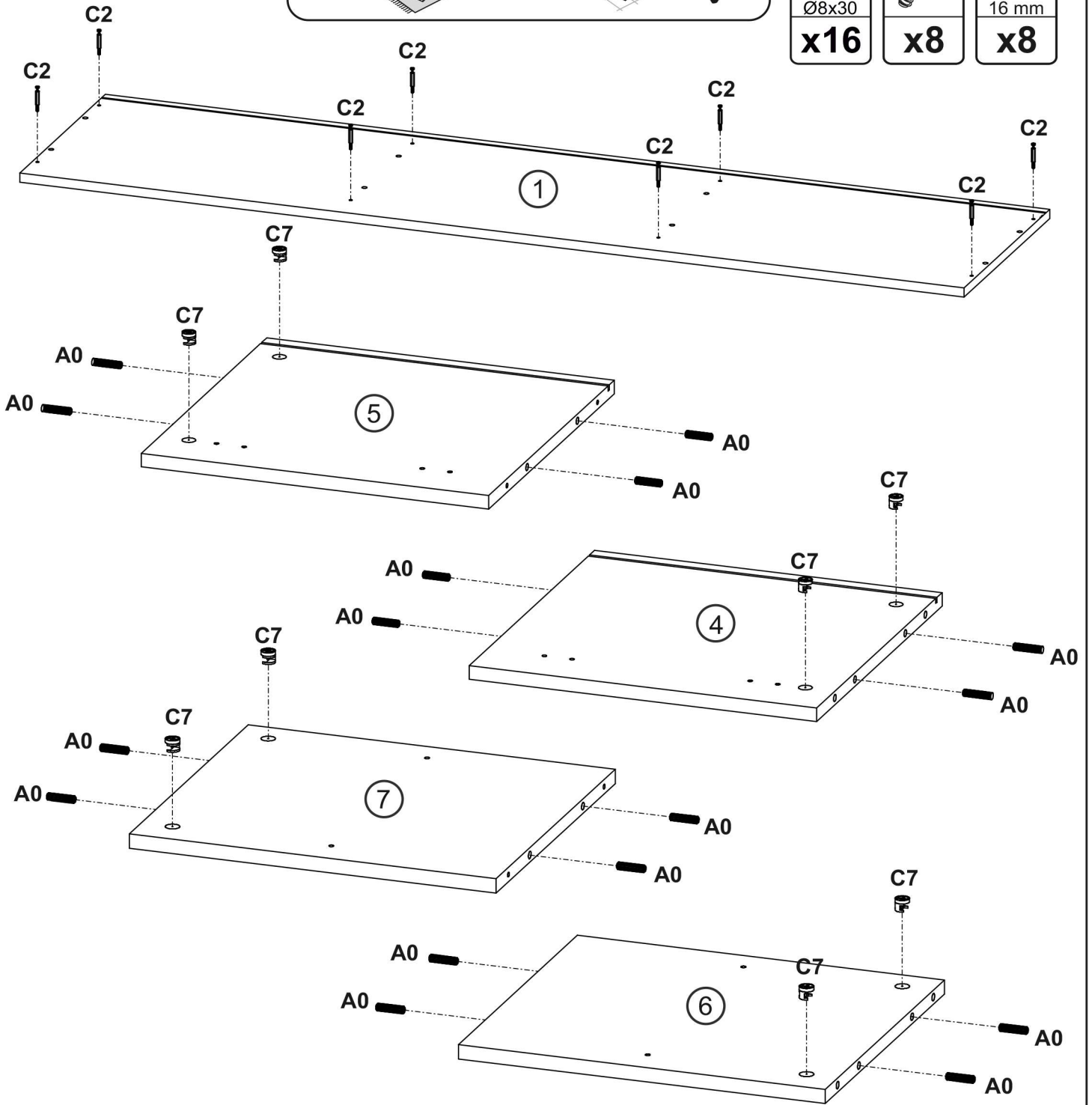

2

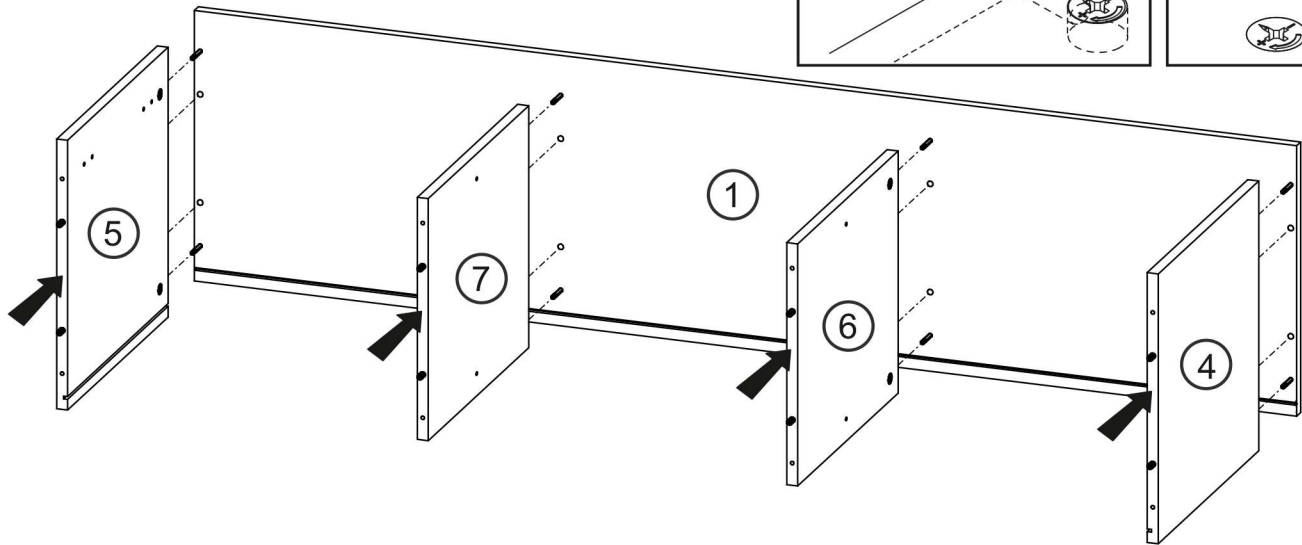
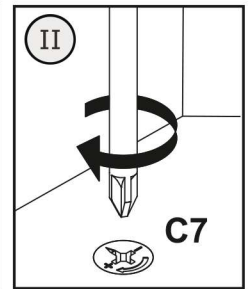
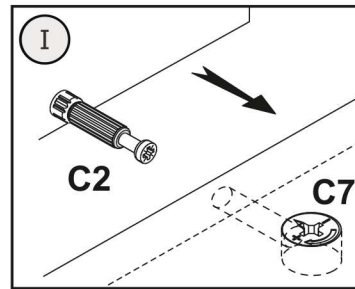
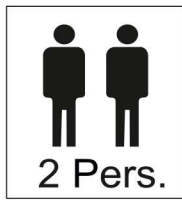

3

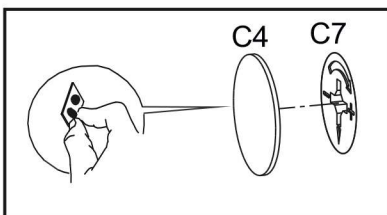
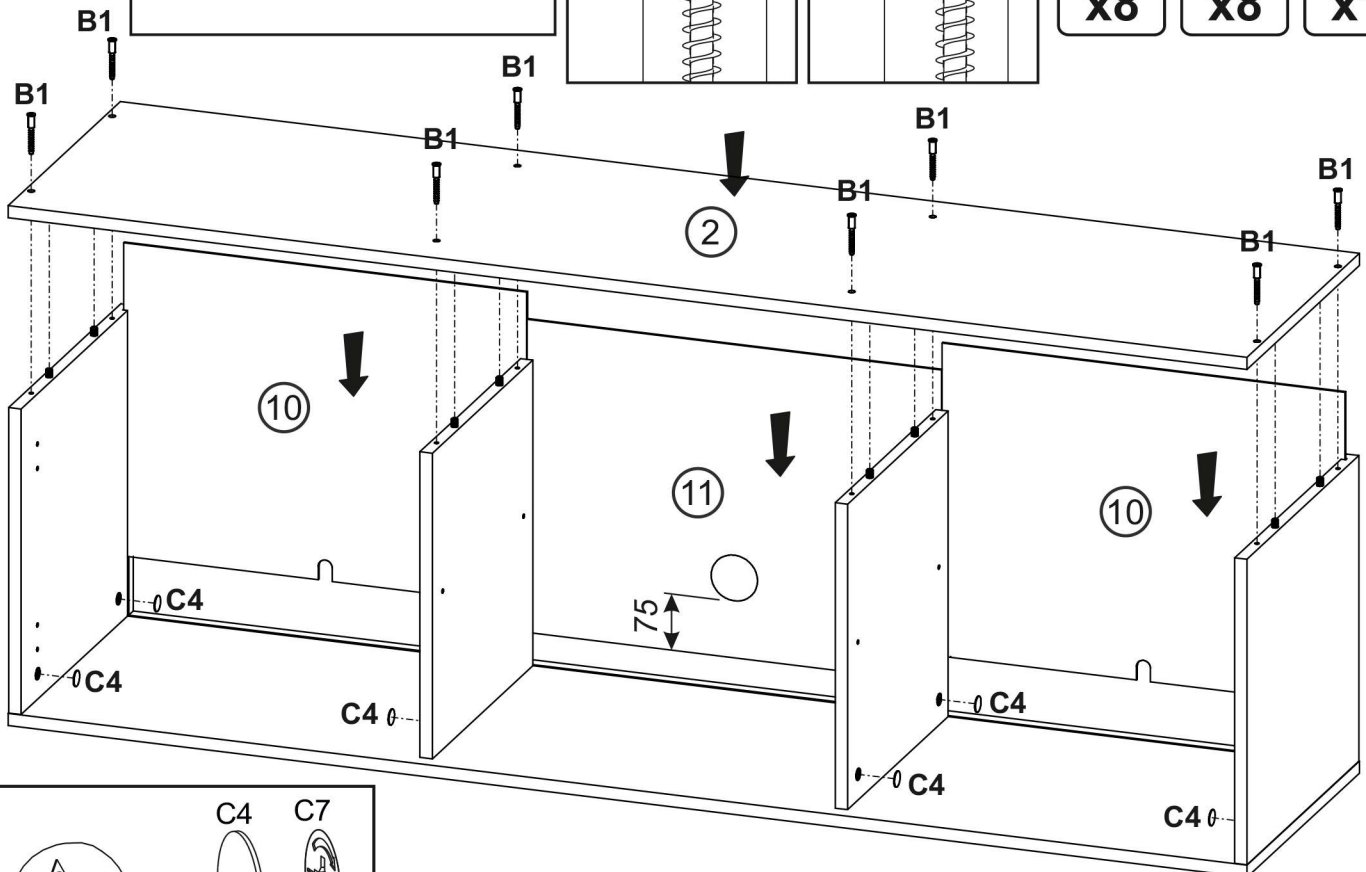
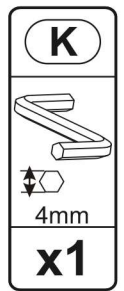
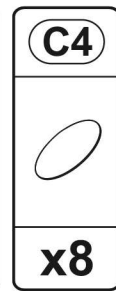
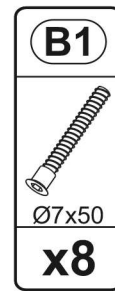
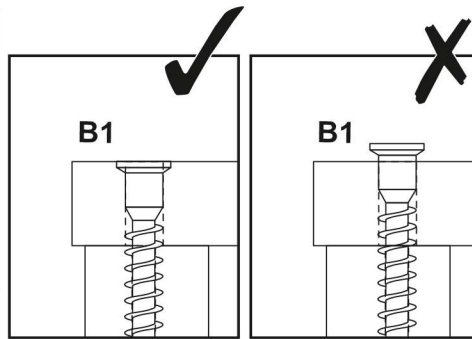
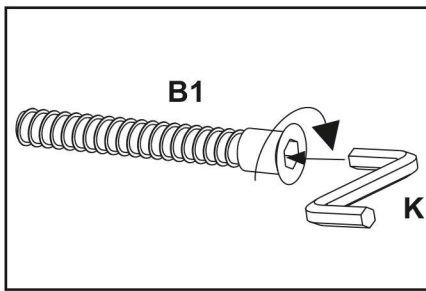

4

3.5x16



D5

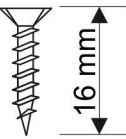

3.5x16



D4

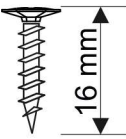

B4	D4	T7	T20
x4	x20	x1	x4

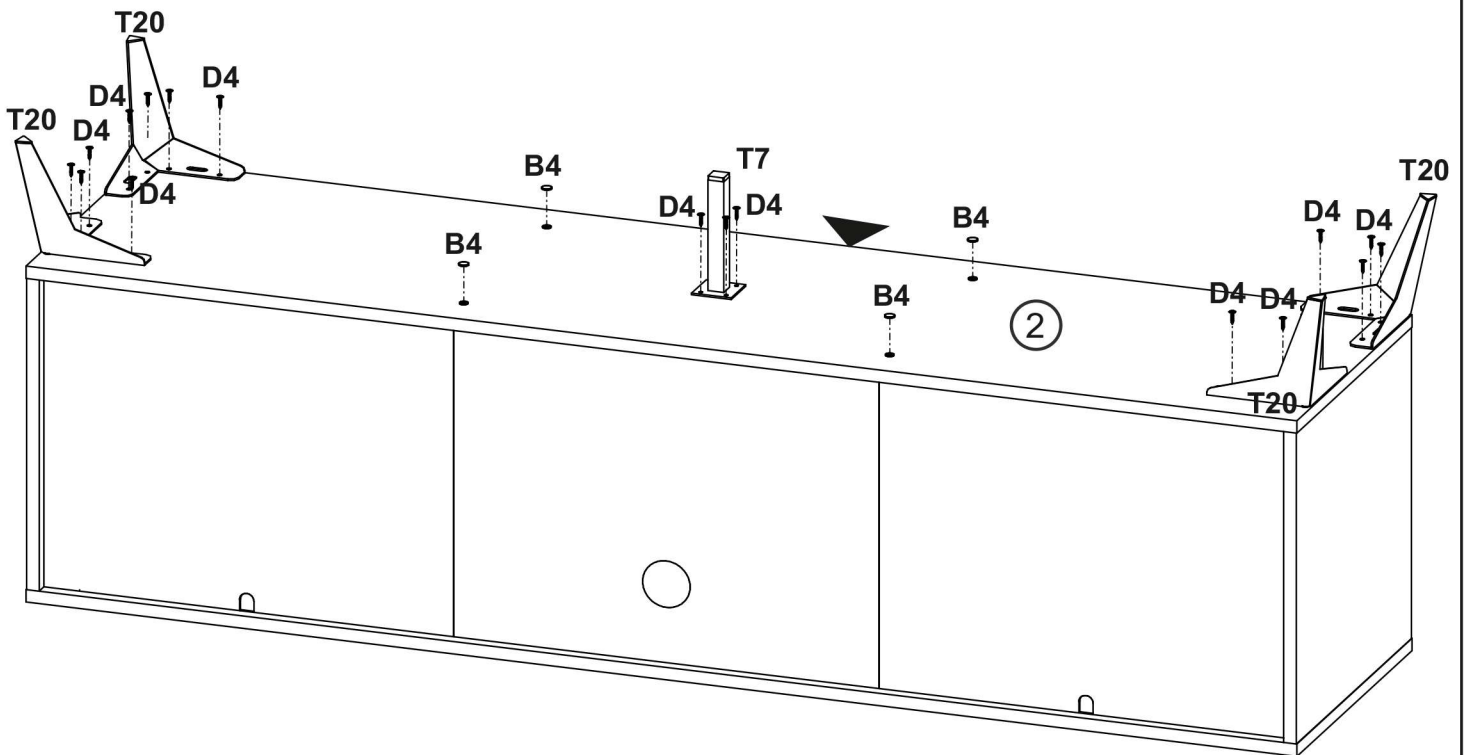
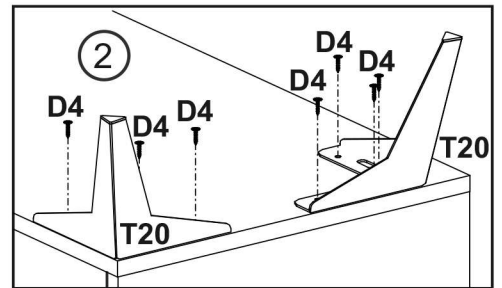
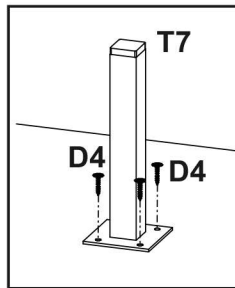
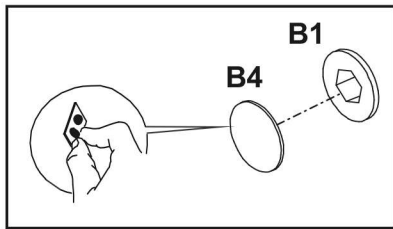
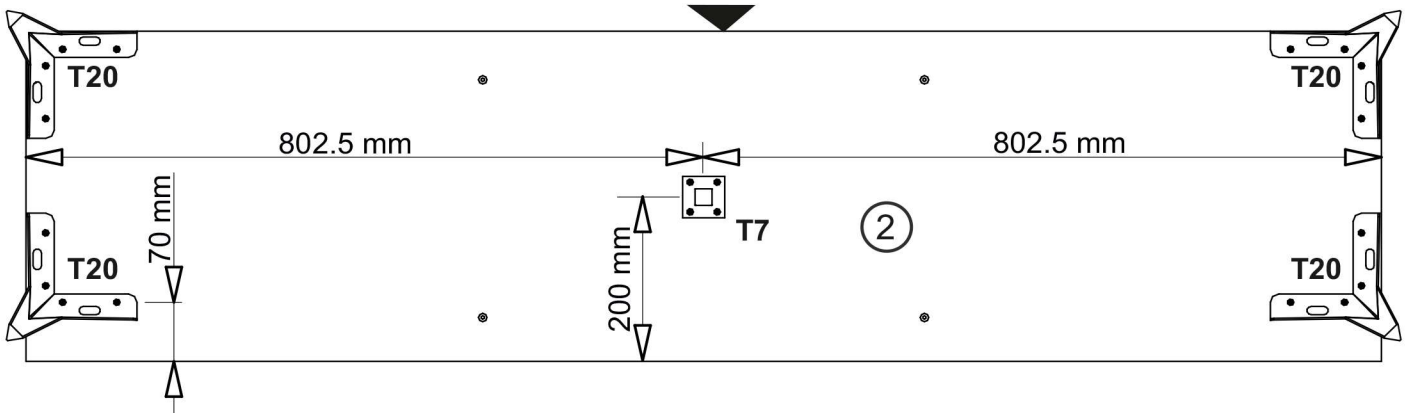

5

3.5x16



D5

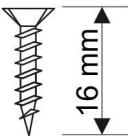

16 mm



3.5x16



D4

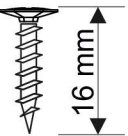

16 mm

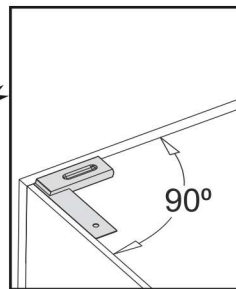
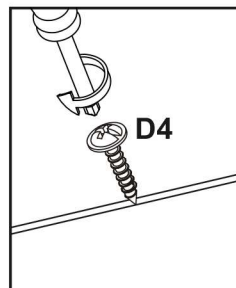

D5	M1	D4
3.5x16		3.5x16
x16	x16	x4

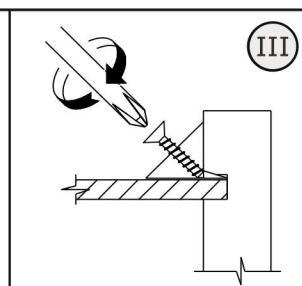
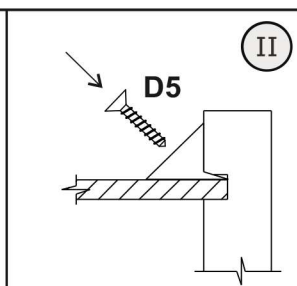
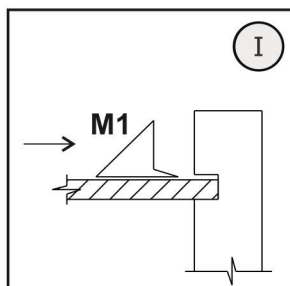
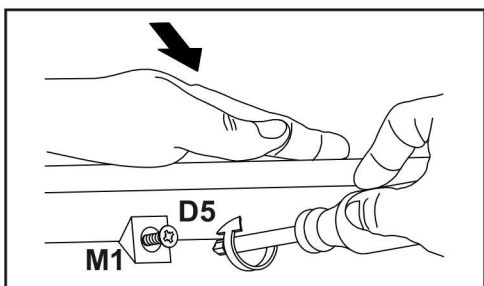
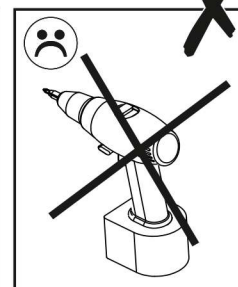
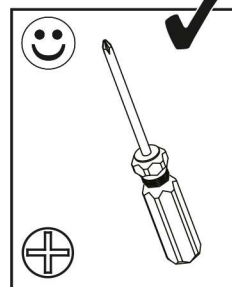
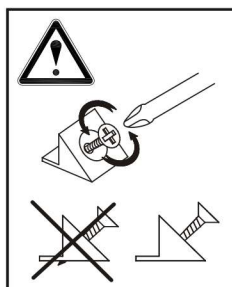
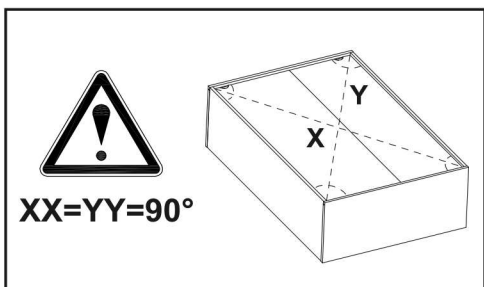
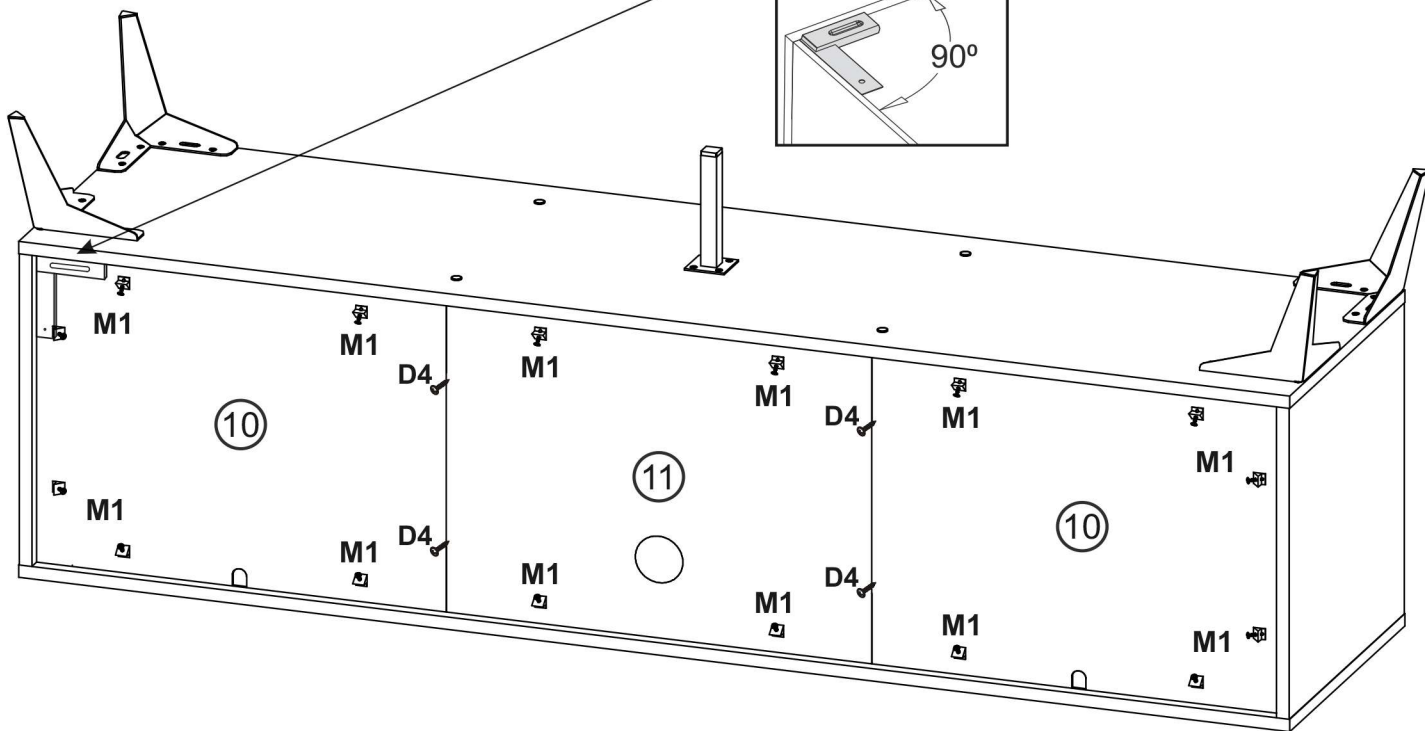

6

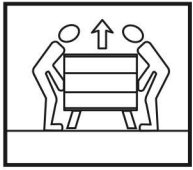



3.5x16

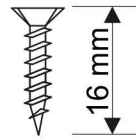

D5



D5	E0	P0
		
3.5x16	8x50	
x4	x2	x2

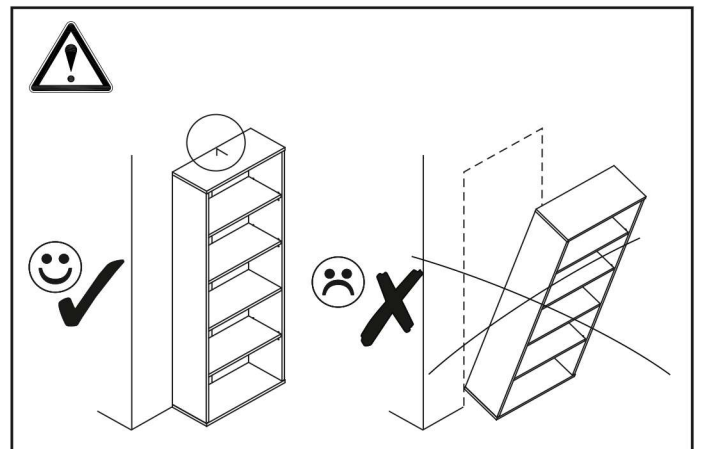
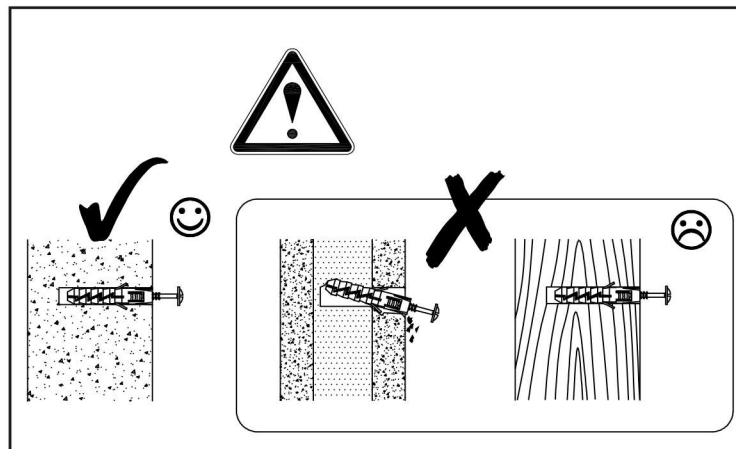
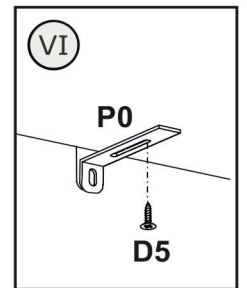
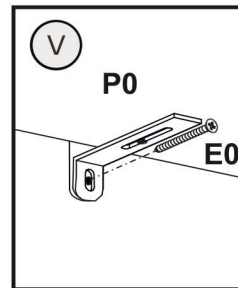
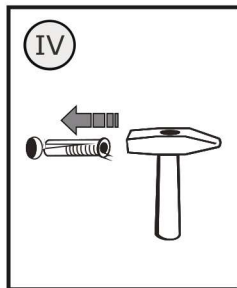
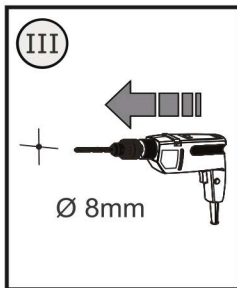
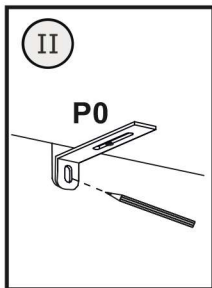
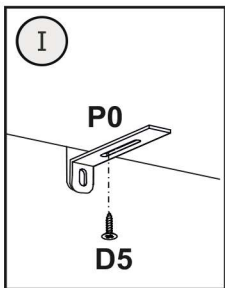
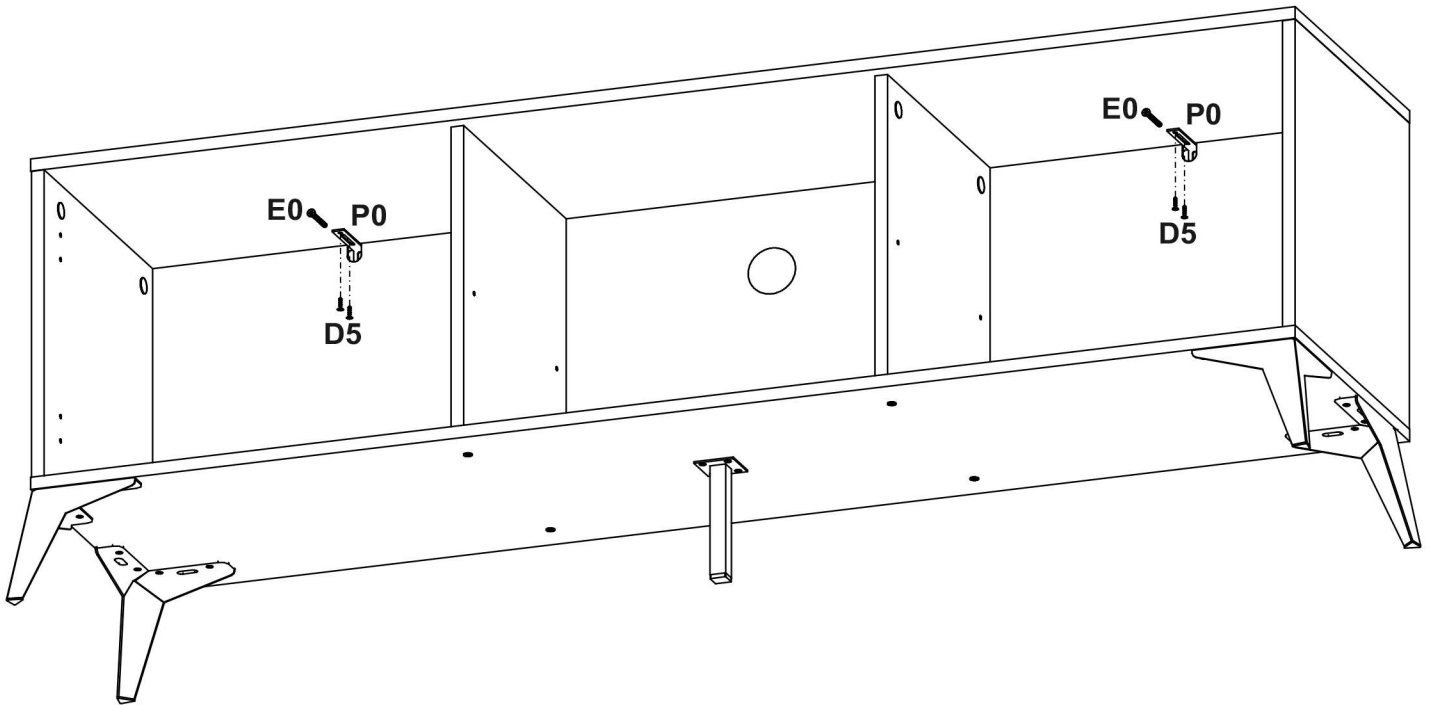

D5

3.5x16
x8

J5

x4

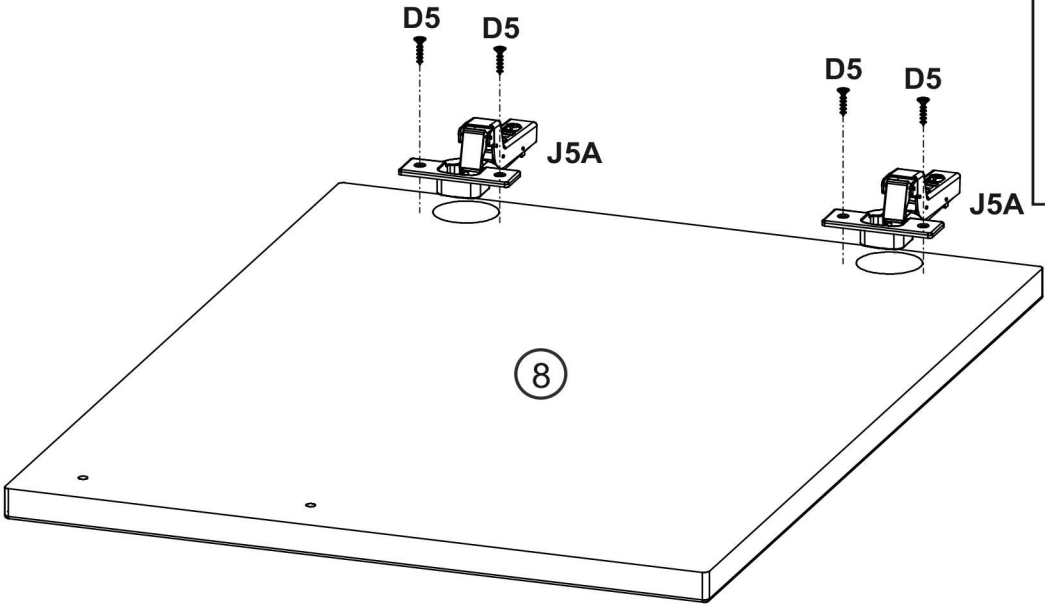
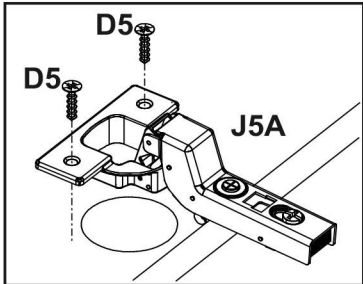
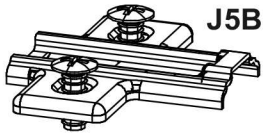
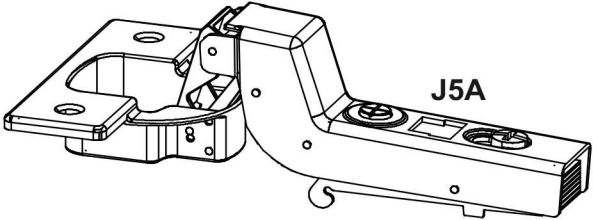
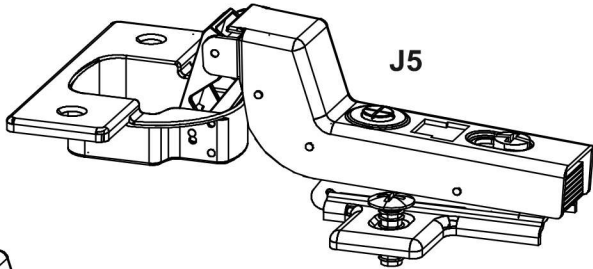

3.5x16



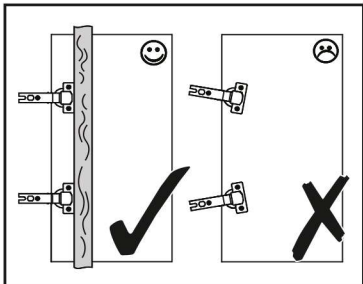
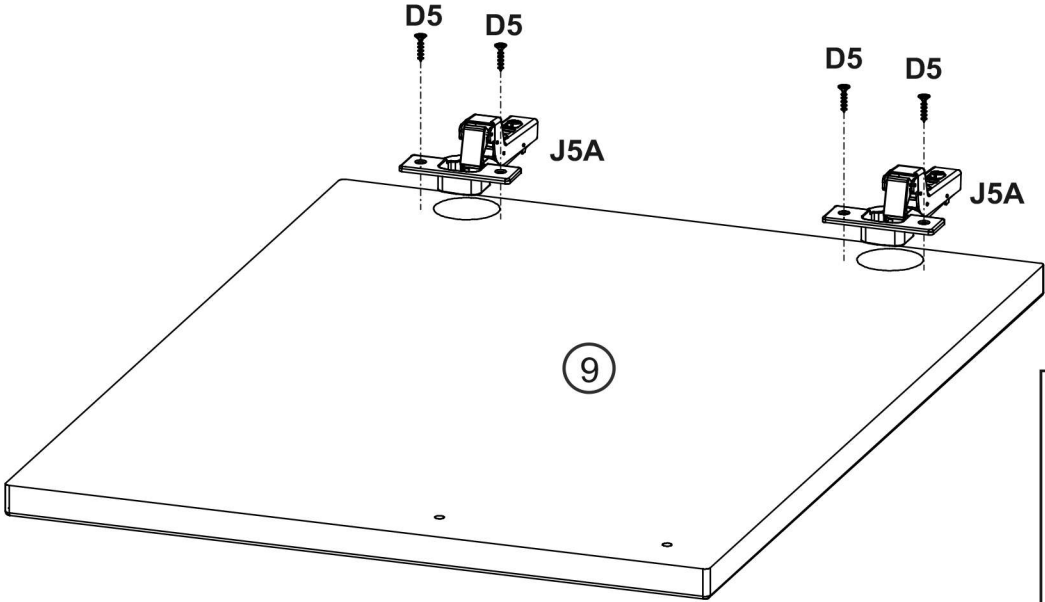
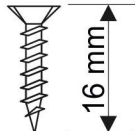

D5

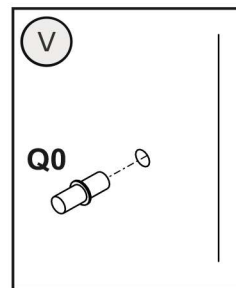
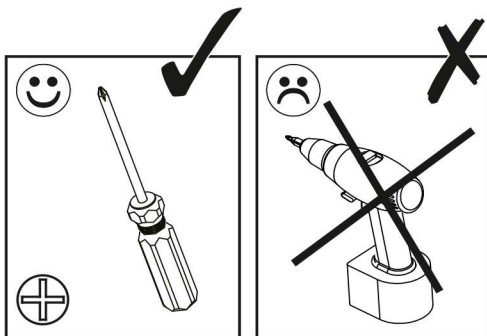
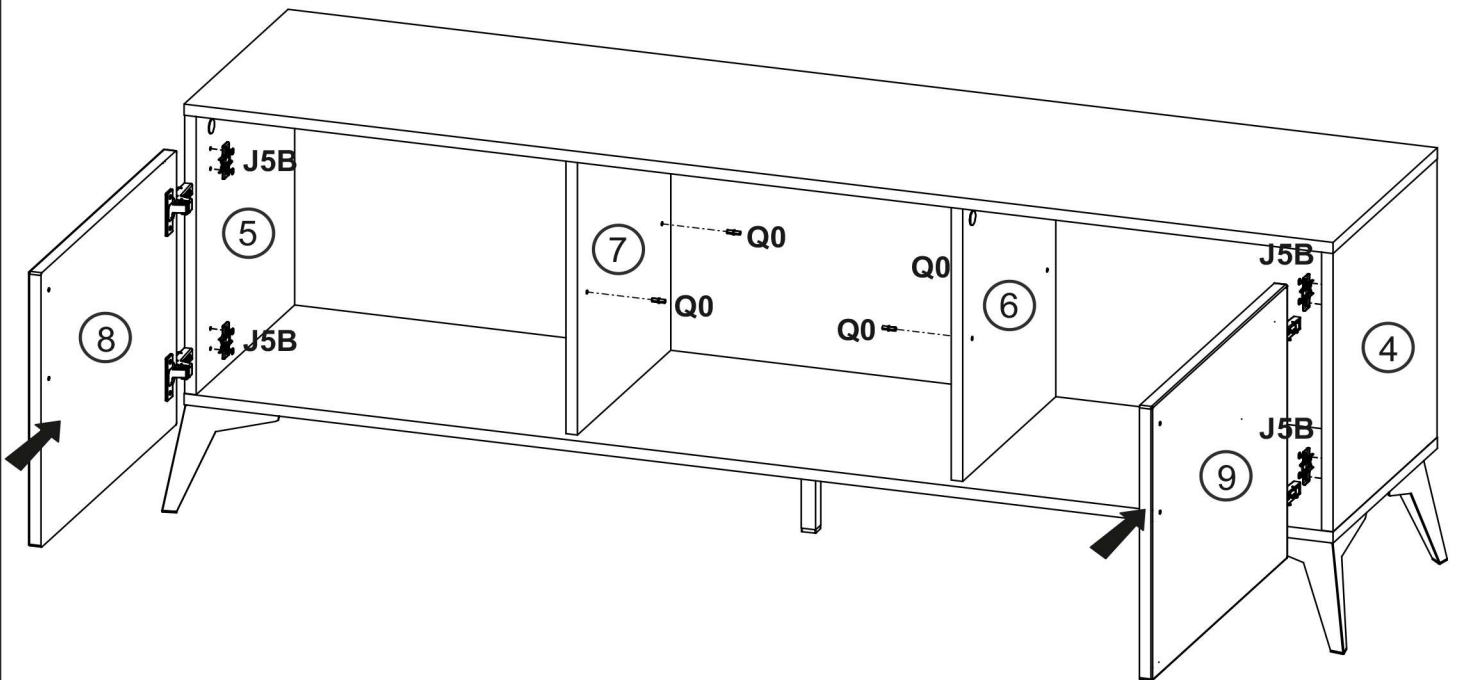
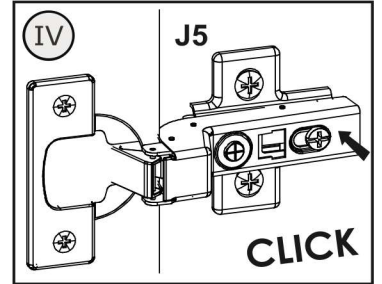
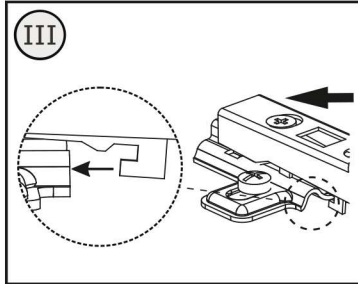
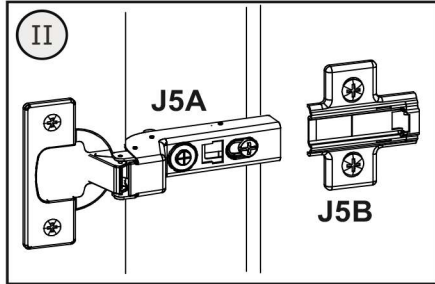
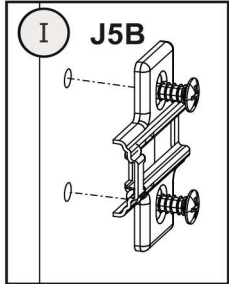

J5B	Q0
x4	x4

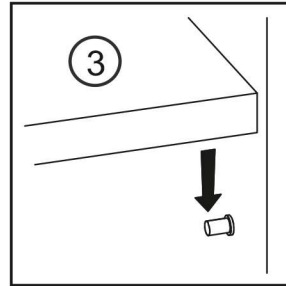
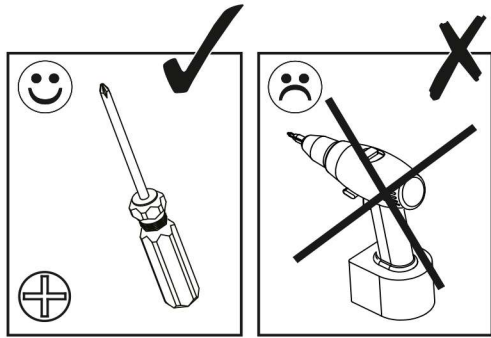



H2	L15
	
4x22	
x4	x2

