

KLODEKAS 5

Art.-Nr.

394 626
394 617

700
624
200
mm

1/4
v0
17-2024



50 min



PZ 2, PZ 1



0,5 kg



3m

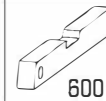

600 mm



Ø10



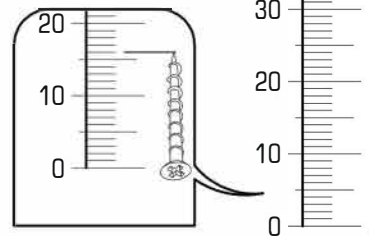
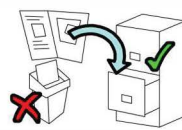
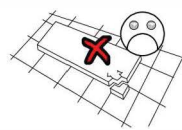
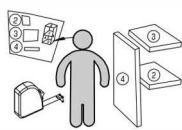
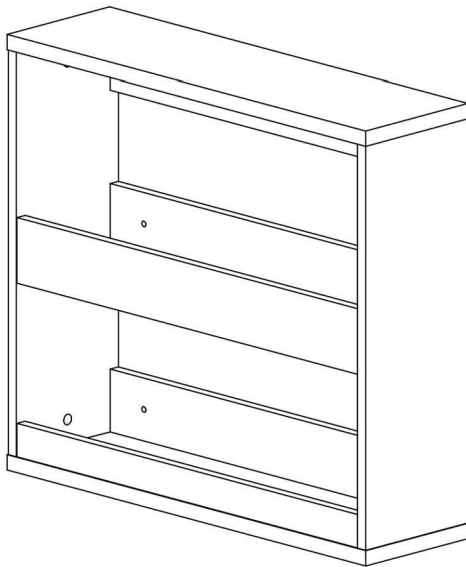
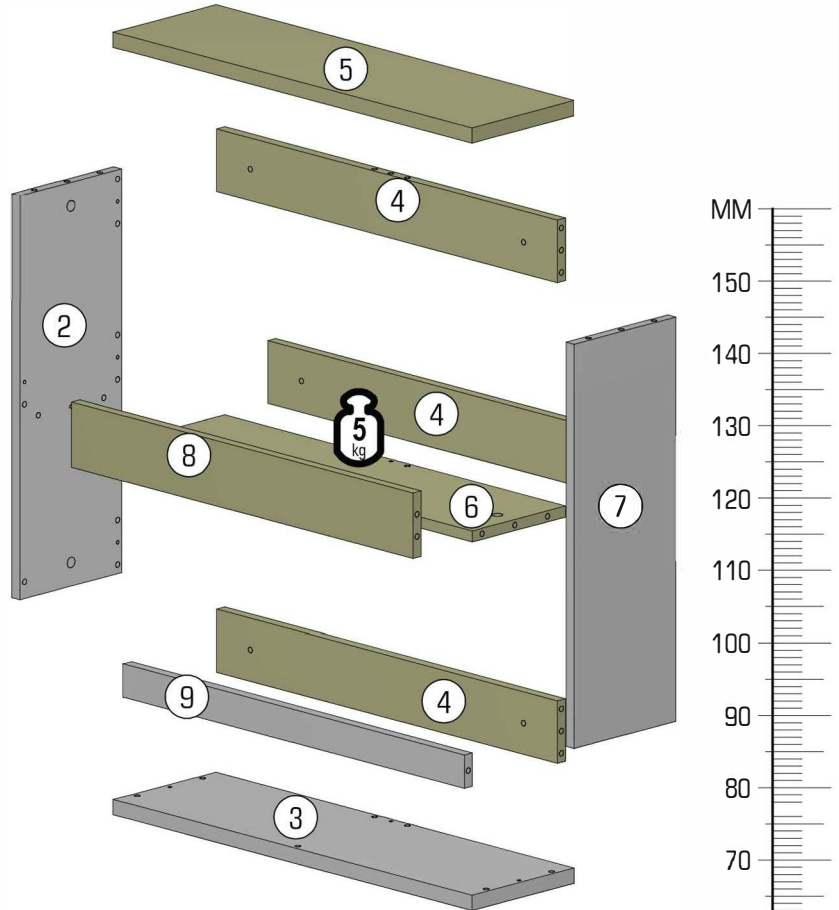

ID	ID	Image	Image	Image
21142	②	580*199*16	1x	1/1
21143	③	700*200*22	1x	1/1
21144	④	666*90*16	3x	1/1
21145	⑤	700*200*22	1x	1/1
21146	⑥	666*182*16	1x	1/1
21147	⑦	580*199*16	1x	1/1
21148	⑧	666*94*16	1x	1/1
21149	⑨	666*48*16	1x	1/1

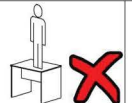

22800.01	Image	4	22304.00	Image	4x	27000.00	Image	37x	Image	4x	24102.02	Image	4x	70013.01	Image	18x	70021.01	Image	18x
A			B	Ø6,30x70		C	Ø8x30		D		E	Ø12		F	Ø15x13		G		



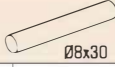

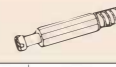
2/4 KLODEKAS 5

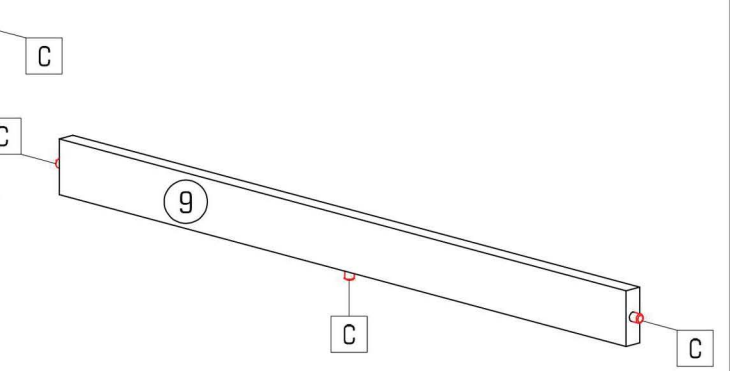
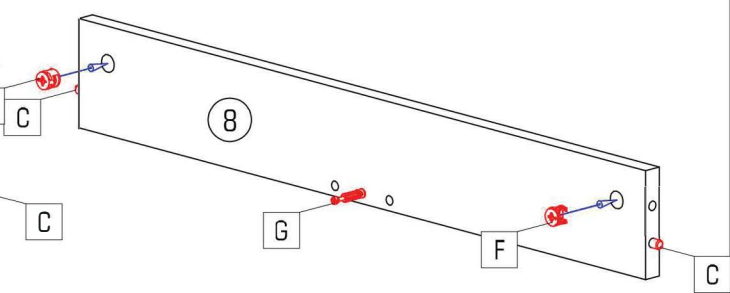
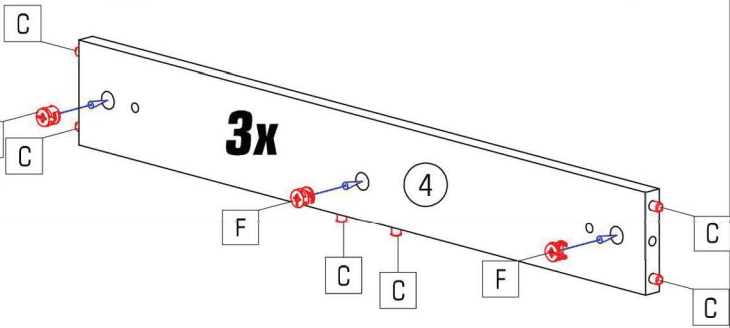
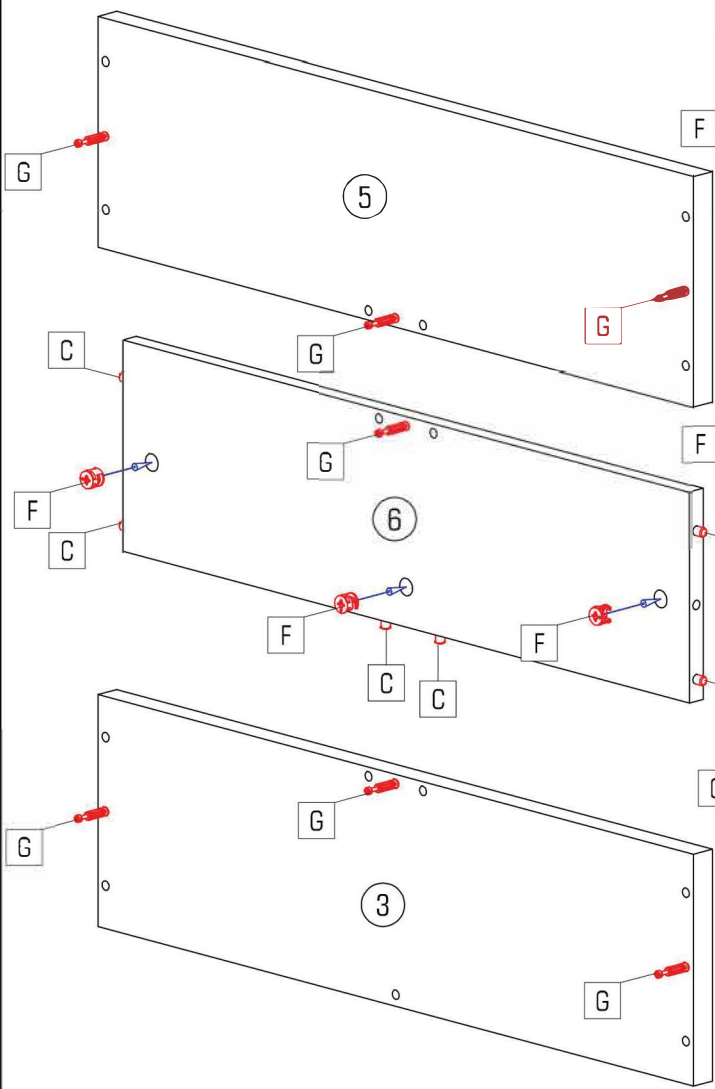
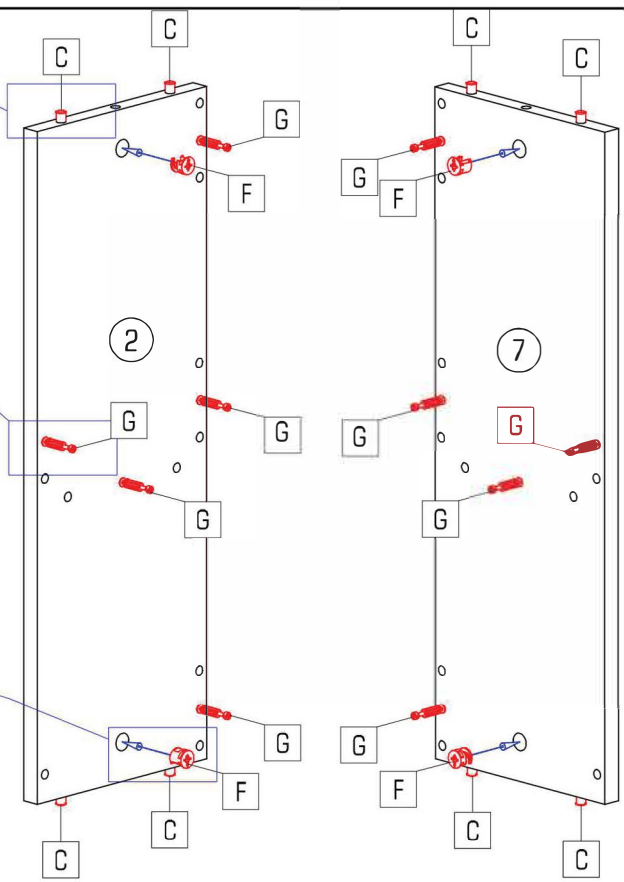
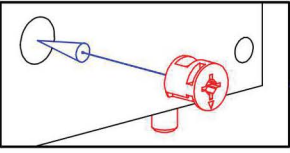
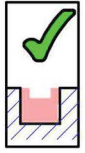
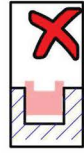
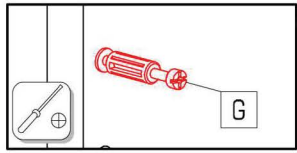
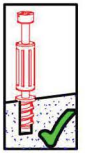
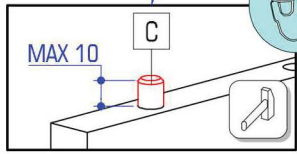
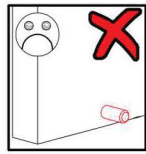
		
Ø8x30	Ø15x13	
C 37x	F 18x	G 18x

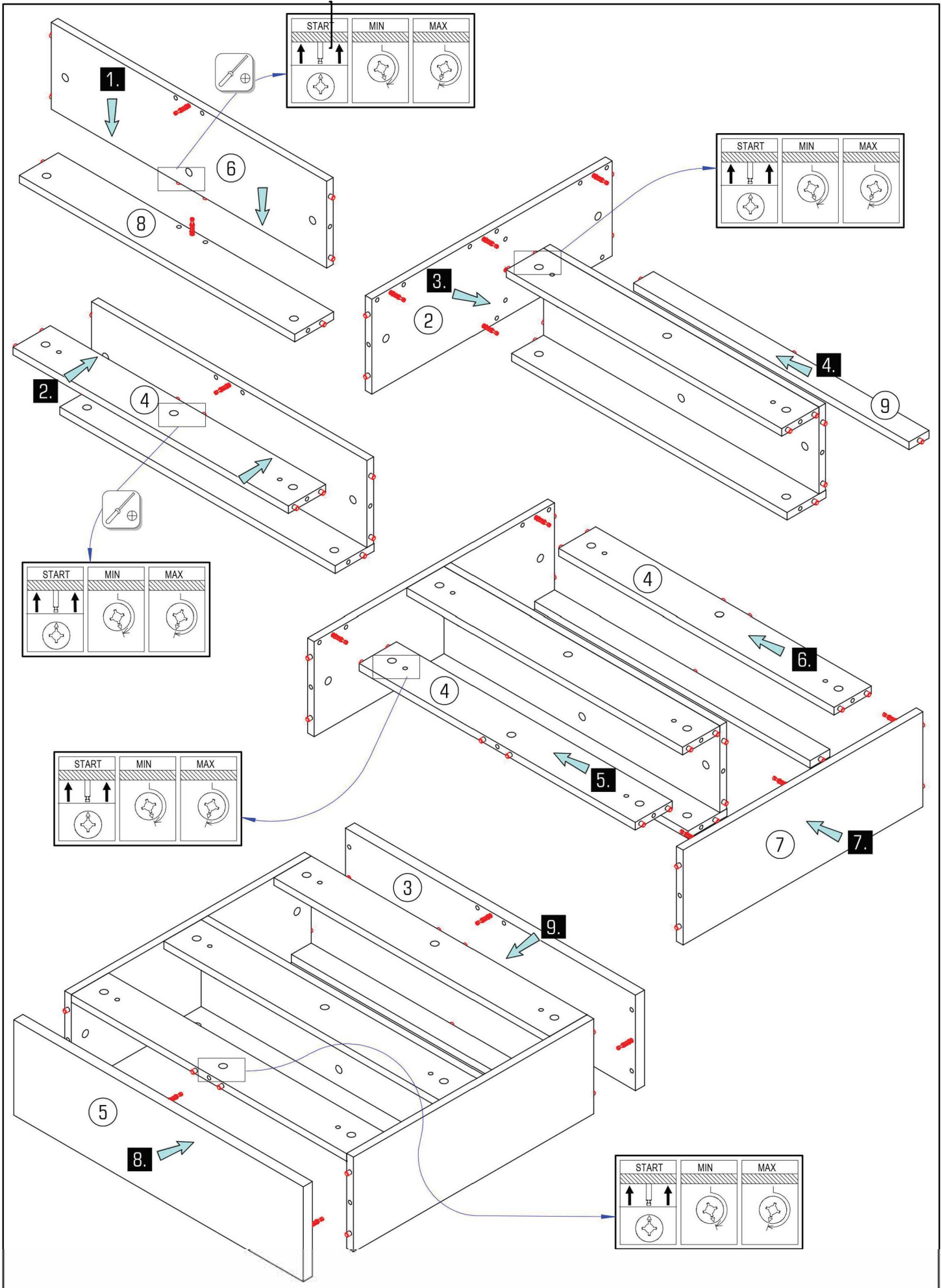



4/4 KLODEKAS 5

		
Ø6.30x70	Ø12	
B 4x	D 4x	E 4x

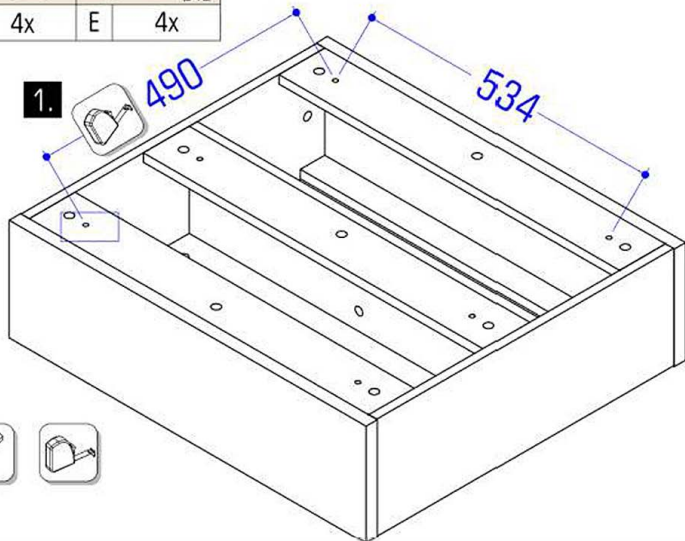
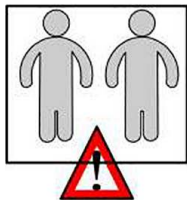

Pozor! Pred montažo preverite sta je stena. Priloženi univerzalni mozniki so izključno samo za uporabo na čvrstem zidovju, kot sta beton in opeka. Stenki mozniki se ne smejo uporabljati pri zidovju kot so votlina opeka, zidali za lahko gradnjo, mavčne plošče ali druge okvirne gradnje. Pri teh zidovjih morate v danih primerih uporabljati posebne moznike. Ti so na voljo v specializiranih trgovinah (trgovinah z gradbenim materialom). Pri upoštevanju se s strani proizvajalca/trgovca in uvoznika ne prevzame jamstvo.

Caution! The wall must be examined before assembly. The included universal wall plugs are only suitable for using in firm masonry such as concrete block or brick. Do not use the wall plugs masonry such as hollow brick, lightweight block, surfaces such as gypsum plasterboard or other framing systems. If applicable, particular wall plugs must be used! These are available at a specialised store (hardware store). In case of non-compliance, the manufacturer/retailer or importer do not assume liability.

Upozorenje! Pevnost steny sa musi pred montažou bezpodmienečne skontrolovat'. Priložene univerzalne hmoždenky používajte jedine pre pevné murivo ako je beton/tehla. Hmoždenky sa nesmú používat' v prípade ľahkého stavebného muriva, dutá tehla, šádrokartónová doska, alebo iných konštrukcií rámu. U týchto stien je nutné použiť špeciálne hmoždenky! Tieto je možné dostať v špeciálnych predajniach so stavebným materiálom. Pri nedodržaní pokynov nepreberajú výrobca/predajca a dodávateľa zodpovednosť za vzniknulé škody.

Upozornění! Před montáží je nutné zkontrolovat stav stěny. Priložene univerzálne hmoždenky jsou určeny pouze k použití pro pevné zdivo jako beton/cihly. Hmoždenky do zdi se nesmí používat' u dutinové cihly, zdívka jako pórovitý stavební kámen, šádrokartónová deska nebo jiný měkký materiál. U těchto zdív jsou nutné použít speciální hmoždenky! Jsou k dostání v speciálních prodejnách se stavebním materiálem. Při nedodržení těchto pokynů výrobce/prodejece a dovozce neručí za způsobené škody.

Pažnja! Prije montaže obavezno provjerite svojstvo zida. Priložene univerzalne tiplje namijenjene su isključivo za masivne zidove od betona/opeke/tiple za masivne zidove ne smiju se koristiti za zidove kao npr šupljina opeka laki sastavni elementi, gips-kartonske ploče ili drugi modularni načini gradnje. Za te zidove potrebne su eventualno specijalne tiplje! Iste su dostupne u specijaliziranim trgovinama građevinskim materijalom. U slučaju nepridržavanja prethodno navedenih napomena, proizvođač/trgovac i uvoznik ne preuzimaju odgovornost!

Achtung! Die Wandbeschaffenheit ist vor der Montage unbedingt zu prüfen. Die beigelegten Universaldübel sind ausschließlich nur zur Verwendung für festes Mauerwerk wie Beton/Ziegel. Die Mauerdübel dürfen nicht bei Mauerwerk wie Hohlraumziegel, Leichthausteinen, Gipskartonplatte oder anderer Rahmenbauweise verwendet werden. Bei diesen Mauerwerken sind gegebenenfalls Spezialdübel zu verwenden! Diese sind in einem Fachgeschäft erhältlich. Bei Nichteinhaltung wird seitens Produzenten/Händler und Importeur keine Haftung übernommen.

Vigyázat! Szerelés előtt a falfelületet feltétlenül vizsgálja meg. A mellékelt univerzális tiplik kizárólag stabil falazathoz használható mint például beton/tégla. A fal tiplje nem használható könnyű építőkövekhez, üreg tégla, gipszkarton lapokhoz vagy más favázás építményekhez. Ezekhez a falfelületekhez csak speciális tiplik használhatóak, melyek szaküzletekben (barkácsruházakban) beszerezhetőek. Fentiek figyelmen kívül hagyása esetén a gyártó/kereskedő vagy forgalmazó nem vállal felelősséget.

Prudenjâ! Zidul trebuie examinat înainte de asamblare prizo de perete sunt adecvate numai pentru utilizarea în zidurile ferme, cum ar fi betonul bloc sau cărămidă. Nu folosiți zidăria zidurilor de perete, cum ar fi cărămida goală, blocul ușor, suprafețe cum ar fi gips-carton sau alți încadrări sisteme. Dacă este cazul, trebuie folosite anumite prizo de perete! Acestea sunt disponibile la un magazin specializat (magazin de hardware). În caz de nerespectare, producătorul / vânzătorul cu amănuntul sau importatorul nu își asumă răspunderea.

Uwaga! Ścianę należy sprawdzić przed montażem. Dołączone uniwersalne kołki rozporowe są odpowiednie tylko do stosowania w mocnych murach, takich jak beton lub cegła. Nie robć za pomocą kołków rozporowych murów, takich jak pustak, lekka kostka, powierzchnie takie jak płyty gipsowo-kartonowe lub inne systemy ram. Jeśli dotyczy, muszą to być określone kołki rozporowe być użyty! Są one dostępne w specjalistycznym sklepie niezgodności, producent / sprzedawca lub importer nie ponoszą odpowiedzialności.

