

KLODEKAS 2

Art.-Nr.

394 622
394 614

700
1964
400
[mm]

1/7
v0
17-2024

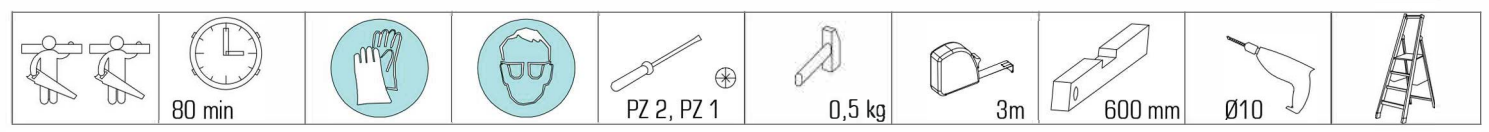

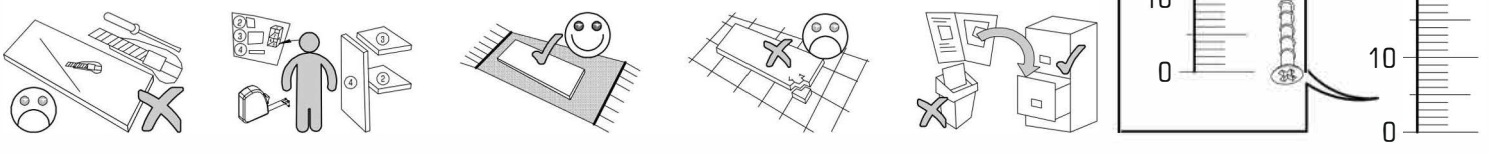
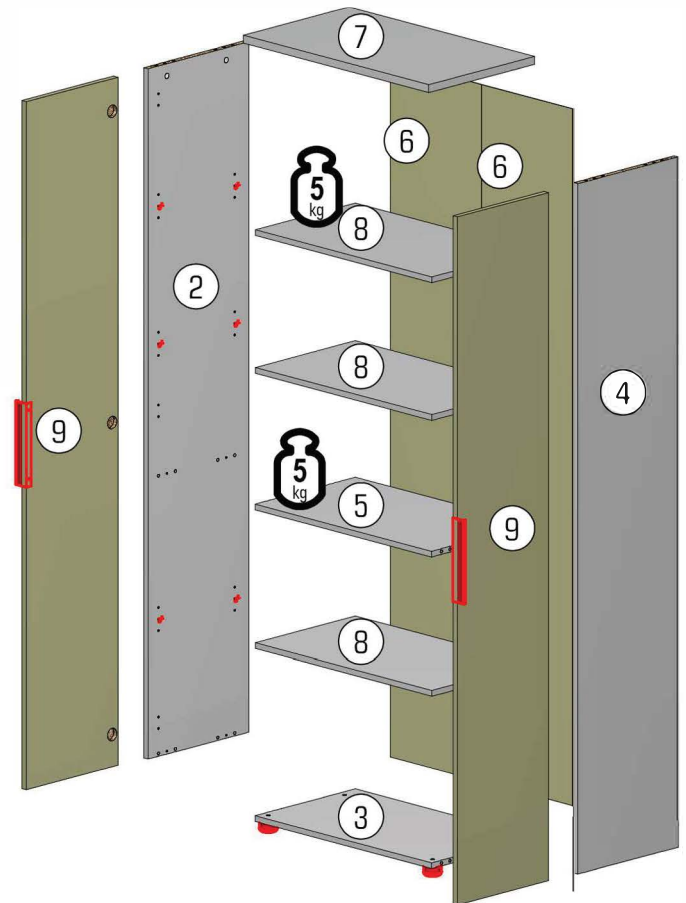
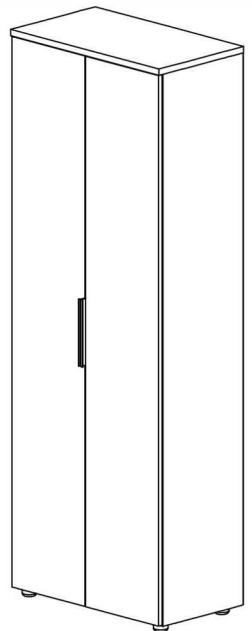

ID	ID			
21100	②	1914*380*16	1x	1/3
21101	③	666*379*16	1x	2/3
21102	④	1914*380*16	1x	1/3
21103	⑤	666*379*16	1x	2/3
21086	⑥	346*1932*3	2x	1/3
21087	⑦	700*400*22	1x	2/3
21104	⑧	666*378*16	3x	2/3
21105	⑨	344*1908*16	2x	3/3



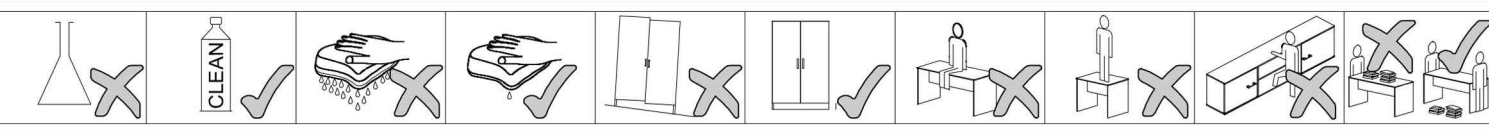

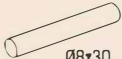
8402.03		Ø8	22256.00		Ø5,0x70	22234.00		Ø3,0x12	22243.00		Ø3,5x15	22244.01		Ø3,5x16	34956.00		22800.01		4	21102.00		Ø1,6x20	24101.00		Ø10
A	2x		B	1x		C	4x		D	12x		E	2x		F	8x	G	1x		H	75x		I	1x	
27000.00		Ø8x30	6501.00			30082.01		Ø50 v=27	31103.00			32246.00		L=230	70013.01		Ø15x13	70021.01			36002.07			36002.07	
L	24x		M	12x		N	4x		P	1x		Q	2x		U	12x		V	12x		X	6x		Y	6x

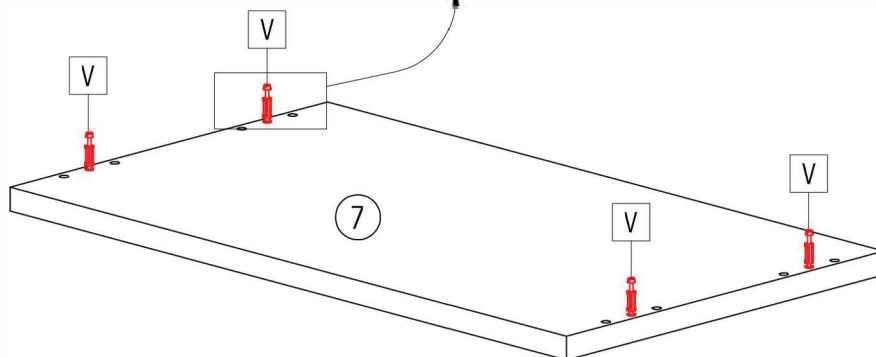
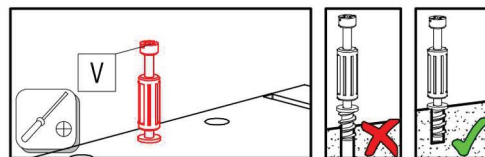
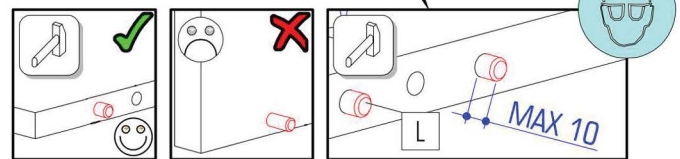
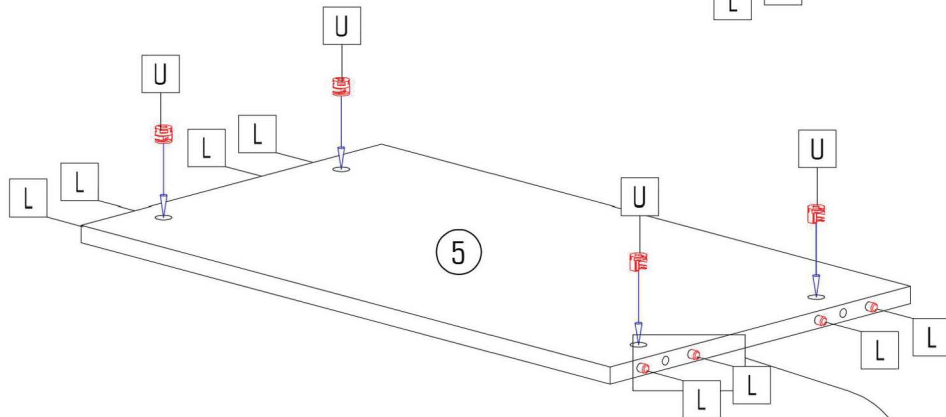
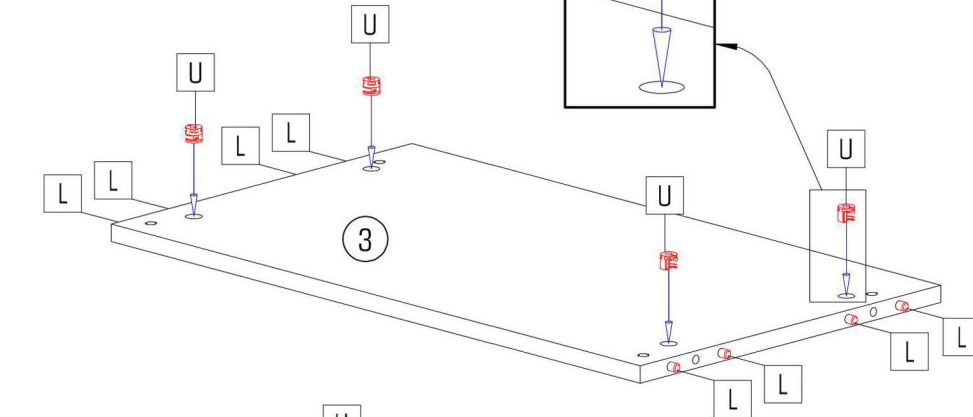
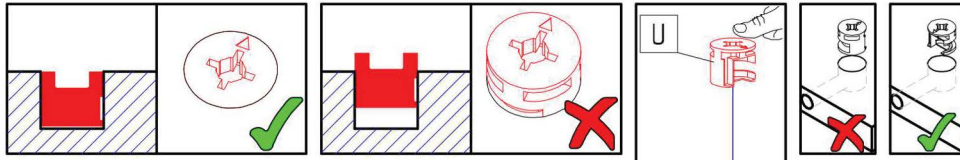
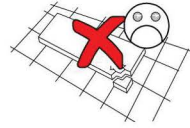

	$\varnothing 8 \times 30$		$\varnothing 15 \times 13$		
L	16x	U	8x	V	4x

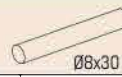

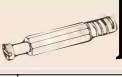
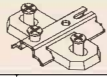
				
L	M	U	V	Y
8x	12x	4x	8x	6x

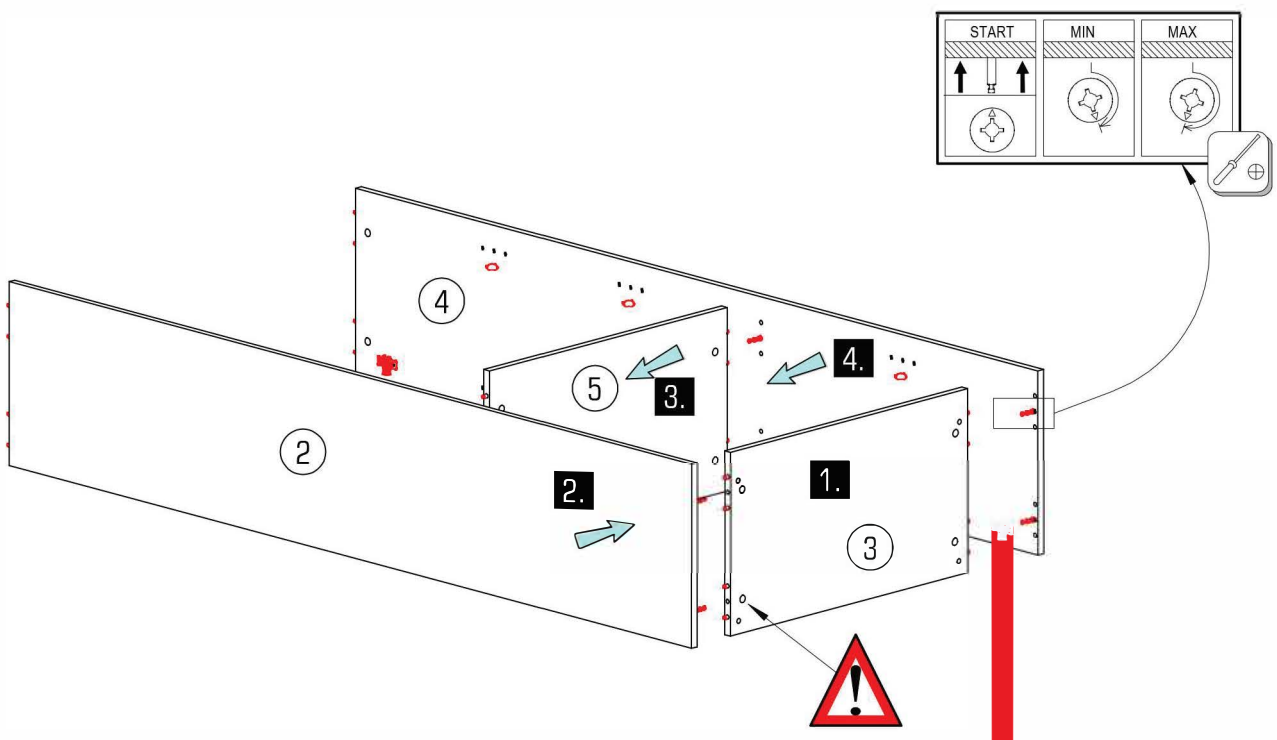
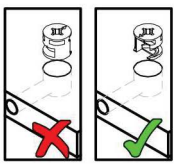
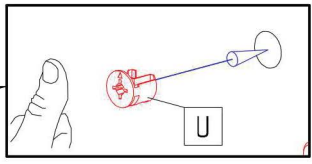
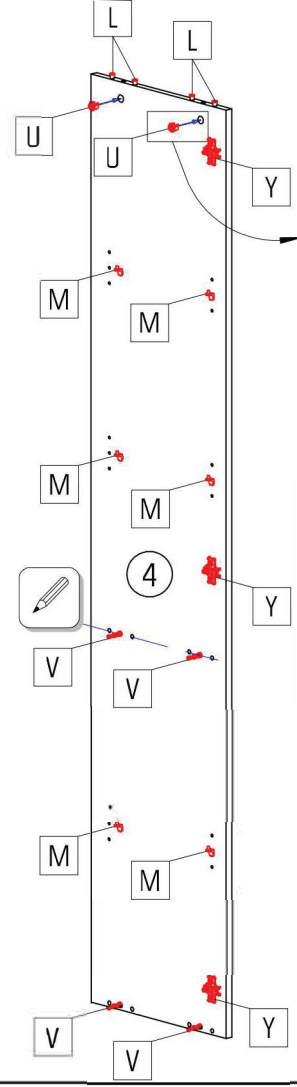
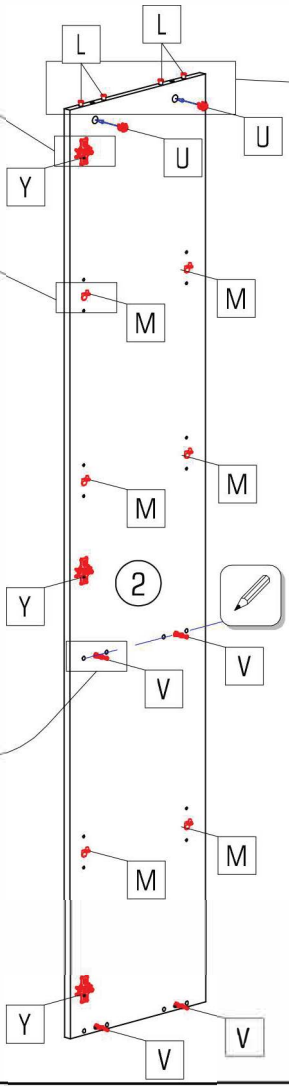
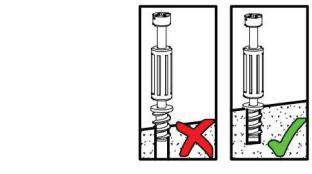
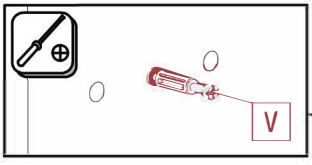
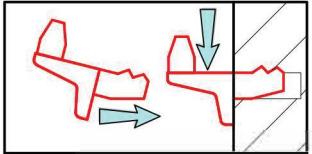
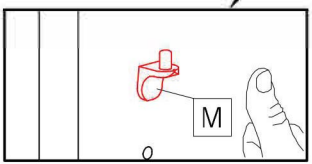
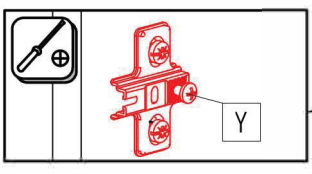
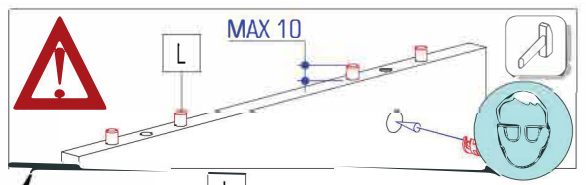



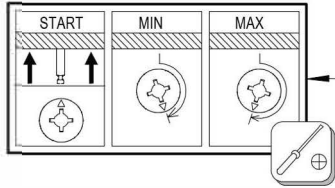
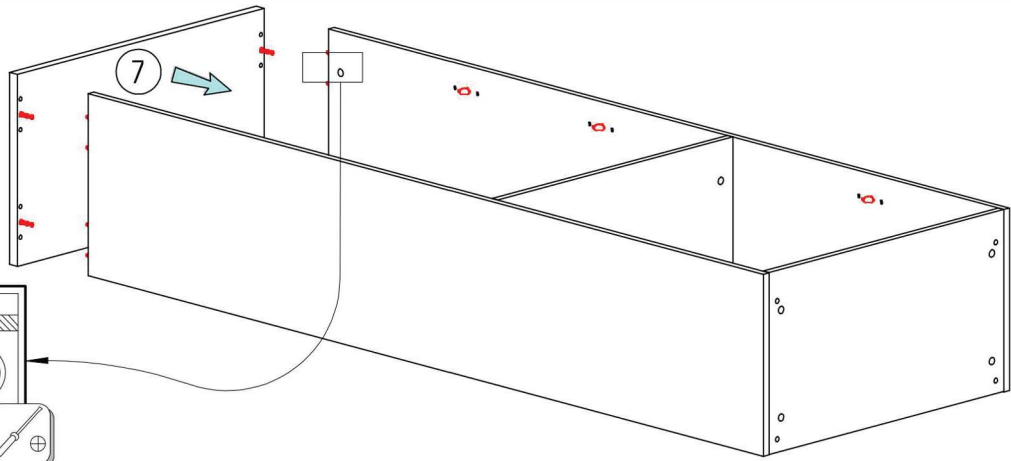

4/7 KLODEKAS 2

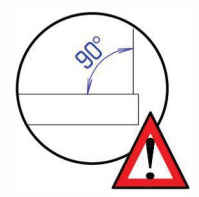
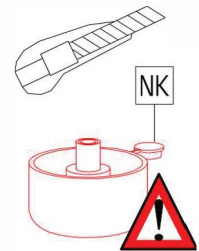
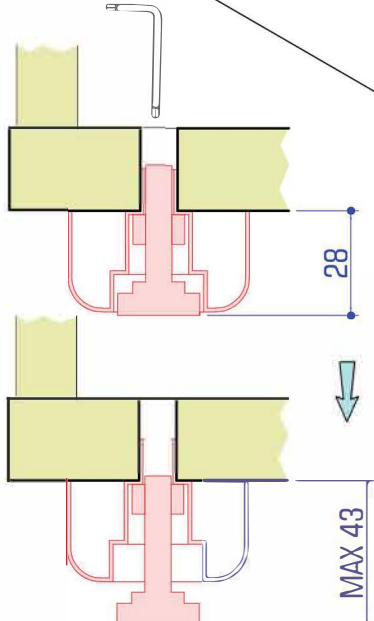
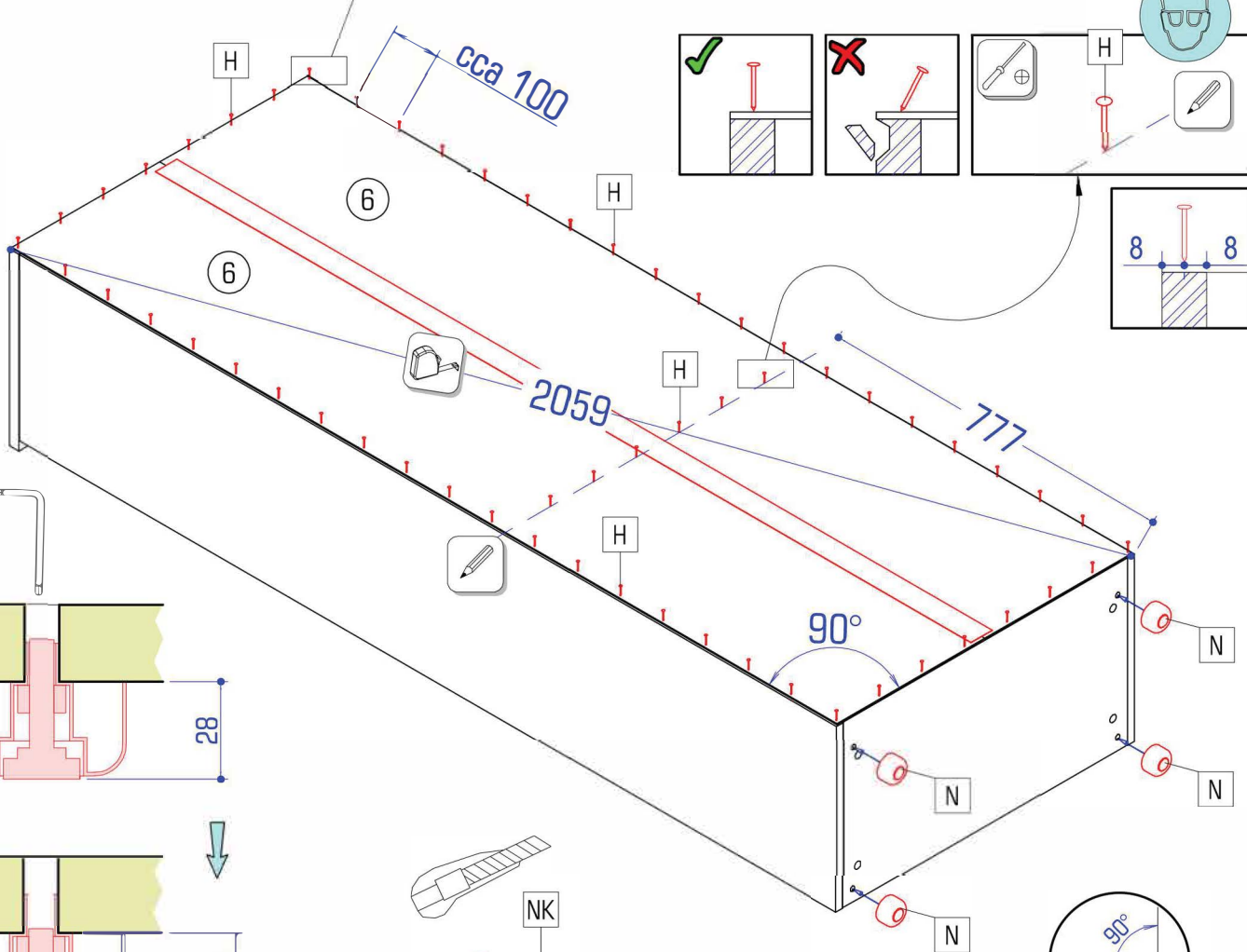
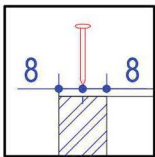
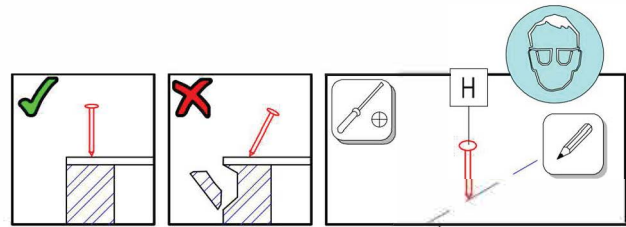
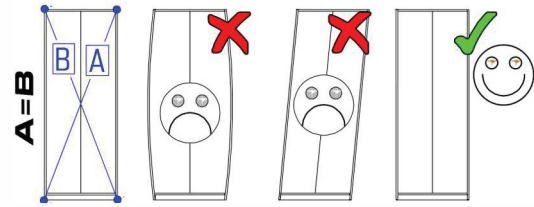
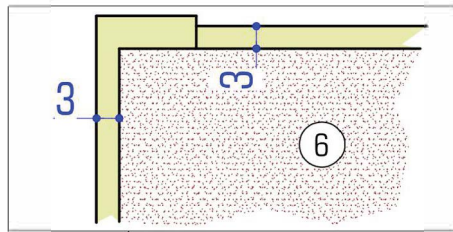
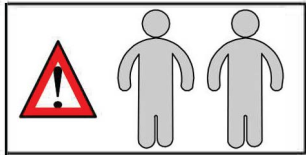



Ø1,6x20	Ø50 v=27
H 75x	N 4x



			
B	E	K	P
1x	2x	1x	1x

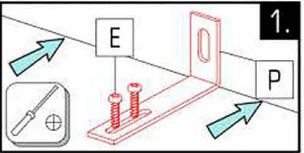
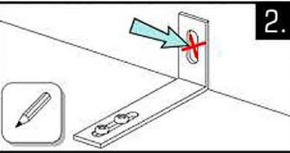
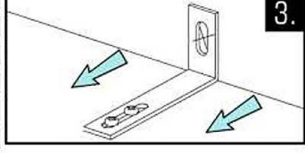
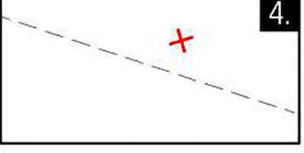
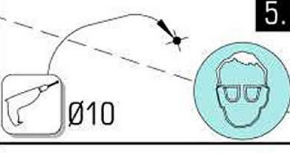
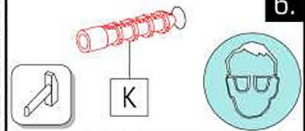

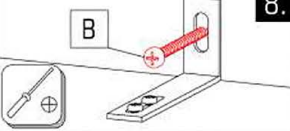
- 
- 
- 
- 
- 
- 
- 
- 

Prudjenj! Zidul trebuie examinat înainte de asamblare prizele de perete sunt adecvate numai pentru utilizare în zidărie formă, cum ar fi betonul bloc sau cărămidă. Nu folosiți zidăria zidurilor de perete, cum ar fi cărămida goală, blocul ușor, suprafețe cum ar fi gips-carton sau altă încălzire sisteme. Dacă este cazul, trebuie folosite anvelope prize de perete! Acestea sunt disponibile la un magazin specializat (magazin de hardware). În caz de nerespectare, producătorul/vanzătorul cu amănuntul sau importatorul nu își asumă răspunderea.

Caution! The wall must be examined before assembly. The included universal wall plugs are only suitable for using in firm masonry such as concrete block or brick. Do not use the wall plugs masonry such as hollow brick, lightweight block, surfaces such as gypsum plasterboard or other framing systems. If applicable, particular wall plugs must be used! These are available at a specialised store (hardware store). In case of non-compliance, the manufacturer/retailer or importer do not assume liability.

Upozornenie! Pevnosť steny sa musí pred montážou bezpodmienečne skontrolovať. Priložené univerzálne hmoždenky používajte jedine pre pevné múrovo ako je betón/tehla. Hmoždenky sa nesmú používať v prípade ľahkého stavebného múru, dutá tehla, sádkartónová doska, alebo iných konštrukcií rámu. U týchto stien je nutné použiť špeciálne hmoždenky! Tieto je možné dostať v špeciálnych predajniach so stavebným materiálom. Pri nedodržiati pokynov nepreberajú výrobcovia/predajci a dodávateľa zodpovednosť za vzniknuté škody.

Upozornění! Před montáží je nutné zkontrolovat stav stěny. Přiložené univerzální hmoždinky jsou určeny pouze k použití pro pevné zdivo jako beton/cihly. Hmoždinky do zdi se nesmí používat u dutinová cihla, zdívka jako porovity stavební kámen, sádkartónová deska nebo jiný měkký materiál. U těchto zdív jsou nutné použít speciální hmoždinky! Jsou k dostání v speciálních prodejních se stavebním materiálem. Při nedodržení těchto pokynů výrobce/prodejce a dovozce neručí za způsobené škody.

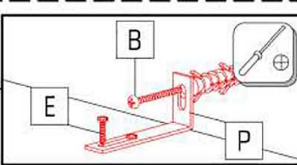
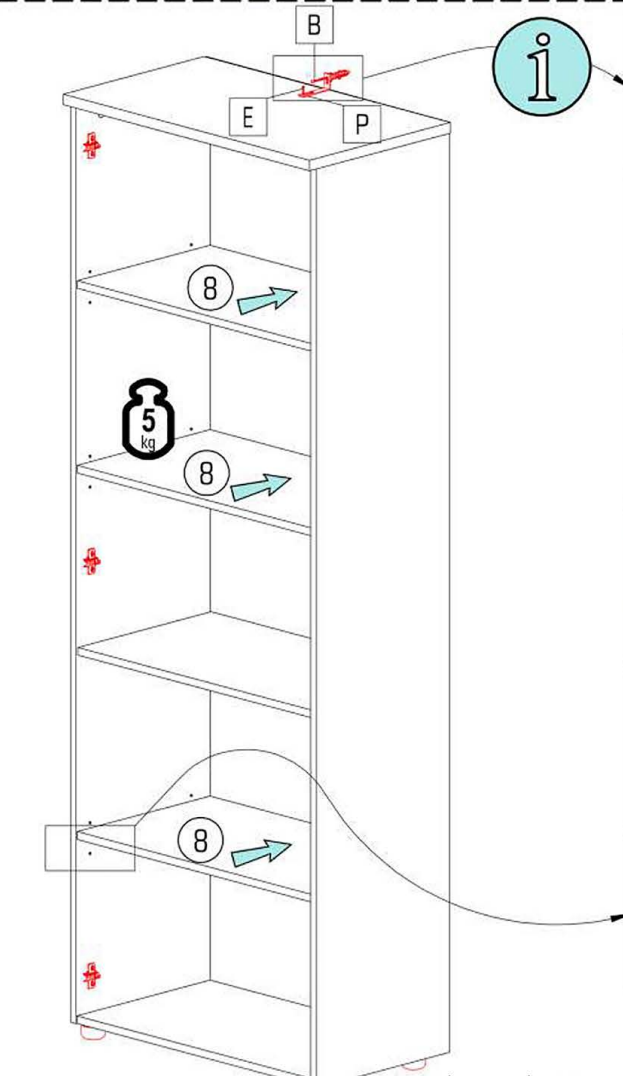

Pažnja! Prije montaže obavezno provjerite svojstvo zida. Priložene univerzalne tiplje namijenjene su isključivo za masivne zidove od betona/opeke. Tiplje za masivne zidove ne smiju se koristiti za zidove kao npr. šupljina opeka laki sastavni elementi, gips-kartonске ploče ili drugi modularni načini gradnje. Za te zidove potrebne su eventualno specijalne tiplje! Iste su dostupne u specijaliziranim trgovinama građevinskim materijalom. U slučaju nepridržavanja prethodno navedenih napomena, proizvođač/trgovac i uvoznik ne preuzimaju odgovornost!

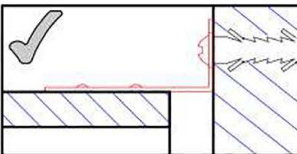

Achtung! Die Wandbeschaffenheit ist vor der Montage unbedingt zu prüfen. Die beigelegten Universaldübel sind ausschließlich nur zur Verwendung für festes Mauerwerk wie Beton/Ziegel. Die Mauerdübel dürfen nicht bei Mauerwerk wie Hohlraumziegel, Leichtbausteinen, Gipskartonplatte oder anderer Rahmenbauweise verwendet werden. Bei diesen Mauerwerken sind gegebenenfalls Spezialdübel zu verwenden! Diese sind in einem Fachgeschäft erhältlich. Bei Nichteinhaltung wird seitens Produzenten/Händler und Importeur keine Haftung übernommen.

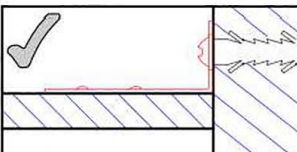

Vigyázat! Szerelés előtt a falfeletet feltétlenül vizsgálja meg. A mellékelt univerzális tiplje kizárólag stabil falazathoz használható mint például beton/tégla. A fali tiplje nem használható könnyű építőkövekhez, üreg tégla, gipszkarton lapokhoz vagy más fázvasas építményekhez. Ezekhez a falfeletekhez csak speciális tiplje használhatóak, melyek szaküzletekben (barkácsruházakban) beszerezhetőek. Fentiek figyelmen kívül hagyása esetén a gyártó/kereskedő vagy forgalmazó nem vállal felelősséget.

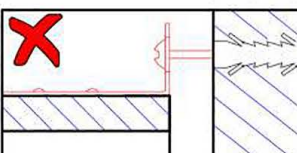

OBS! Väggens sammansättning ska absolut kontrolleras innan monteringen. De bifogade pluggarna får endast användas för stabila och fasta väggar, som t.ex. betong/tegel. De får absolut inte användas för kavitet tegel, väggar ur fonolit, gipskavör eller dylikt. För dessa väggar måste det användas speciella pluggar, som finns att köpa i specialiserad handel (byggmarknad). Varken tillverkare, handlare eller importör övertar ansvar, om dessa anvisningar inte följs.

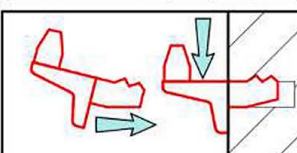

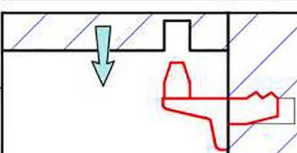

Pozor! Pred muntážou preverite stanje stene. Priloženi univerzalni mozniki so izključno samo za uporabo na čvrstem zidovju, kot sta beton in opeka. Stenski mozniki se ne smejo uporabljati pri zidovju kot so votlina opeke, zidaki za lahko gradnjo, mavčne plošče ali druge okvirne gradnje. Pri teh zidovjih morate v danih primerih uporabljati posebne moznike. Ti so na voljo v specializiranih trgovinah (trgovinah z gradbenim materialom). Pri upoštevanju se s strani proizvajalca/trgovca in uvoznika ne prevzame jamstvo.



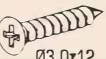
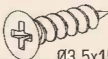
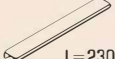

Uwaga! Ścianę należy sprawdzić przed montażem. Dołączone uniwersalne kołki rozporowe są odpowiednie tylko do stosowania w mocnych murach, takich jak beton lub cegła. Nie robć za pomocą kołków rozporowych murowanych, takich jak pustak, lekka kostka, powierzchnie takie jak płyty gipsowo-kartonowe lub inne systemy ram. Jeśli dotyczy, muszą to być określone kołki rozporowe być użyty! Są one dostępne w specjalistycznym sklepie niezgodności, producent / sprzedawca lub importer nie ponoszą odpowiedzialności.

RO AVERTISMENT

- EN WARNING
- SK VÝSTRAHA
- CZ VAROVNÍ
- HR UPOZORENIE
- DE WARNUNG
- HU FIGYELEM
- SE VARNING
- SI OPOZORILO
- PL OSTRZEŻENIE

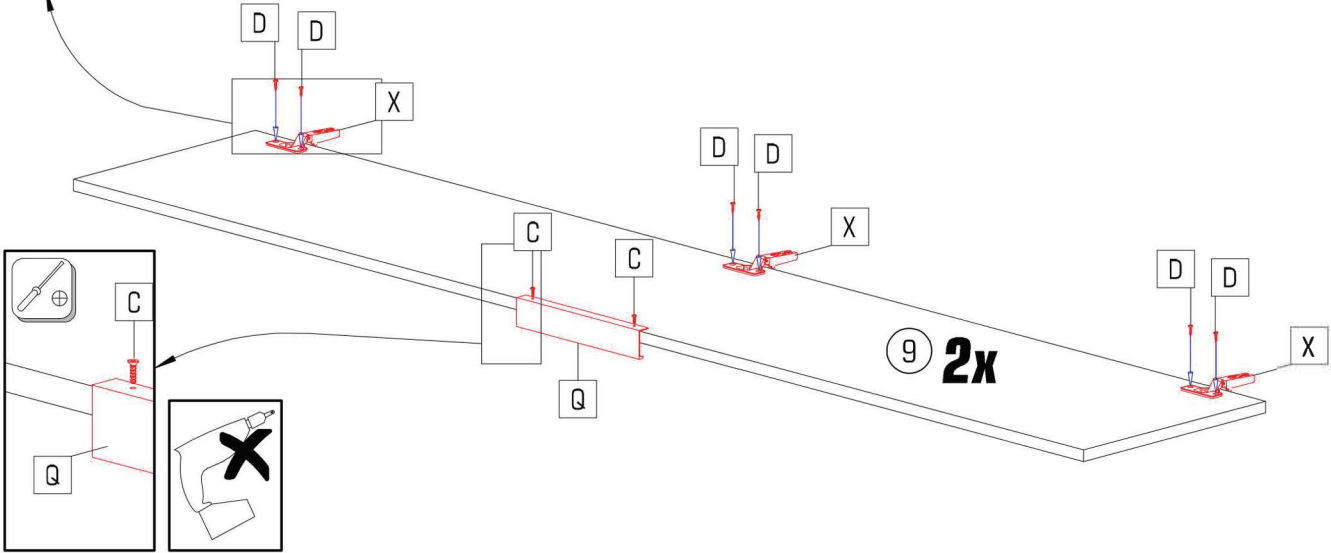
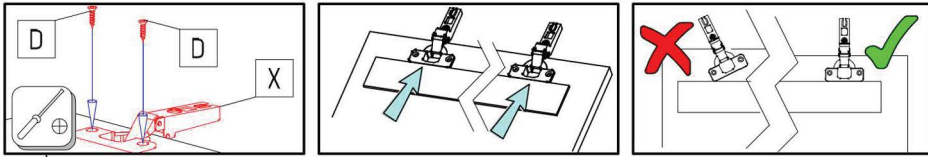
			
C	D	Q	X
4x	12x	2x	6x



	
A	F
1x	8x

