

KLODEKAS 1

Art.-Nr.

394 621
394 613

700
1964
400
mm

1/6
v0
16-2024

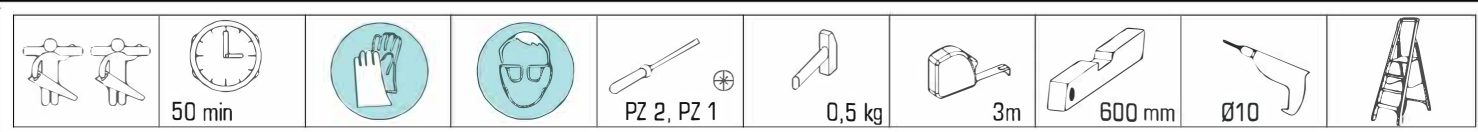

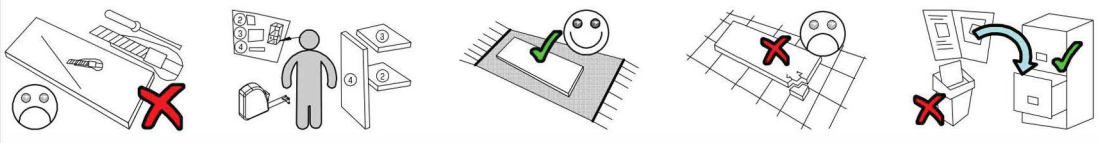
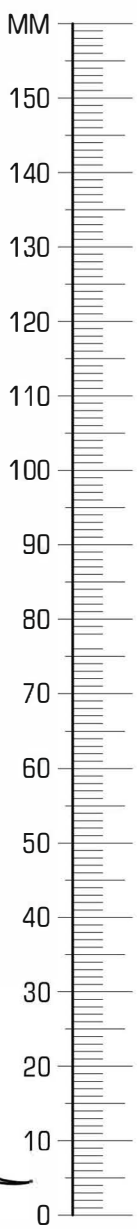
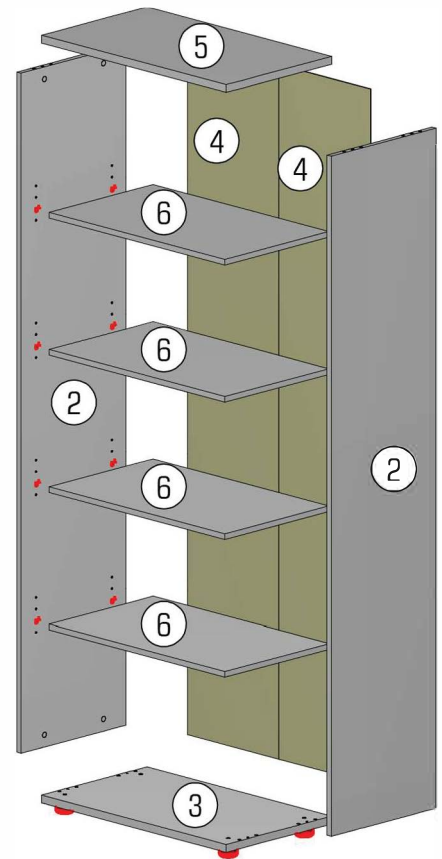
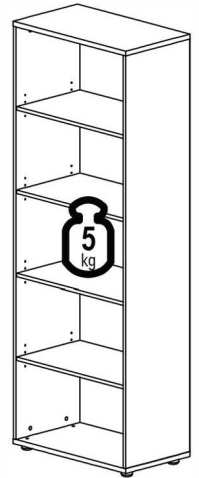

ID	ID	Image	Dimensions	Quantity	Assembly
21084	②		1892*398*16	2x	1/2
21085	③		700*400*22	1x	2/2
21086	④		347*1932*3	2x	1/2
21087	⑤		700*400*22	1x	2/2
21088	⑥		666*394*16	4x	2/2

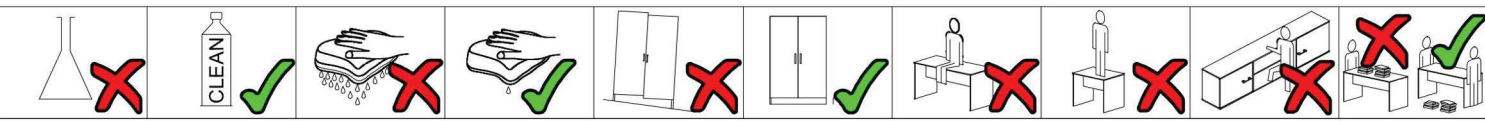

	22800,01 A 1x		22256,00 B 1x		22244,01 E 2x		F 8x
	24101,00 K 1x		27000,00 L 16x		8501,00 M 16x		N 4x
	31103,00 P 1x		21102,00 T 75x		70013,01 U 8x		V 8x



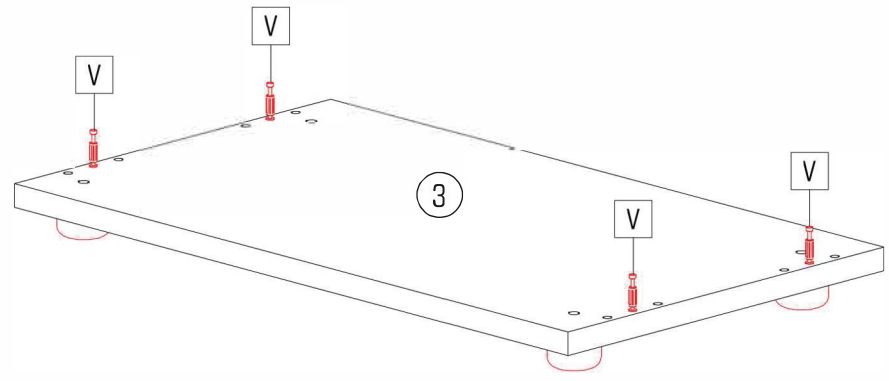
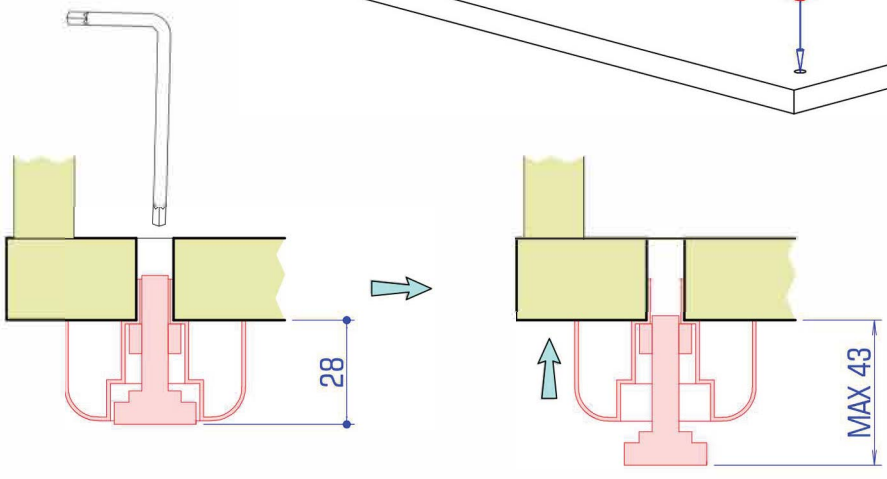
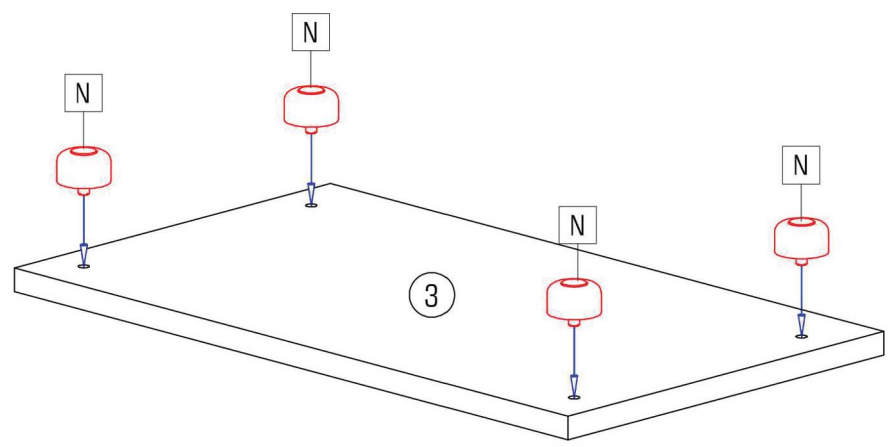
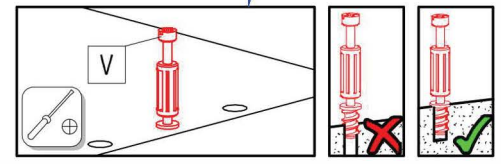
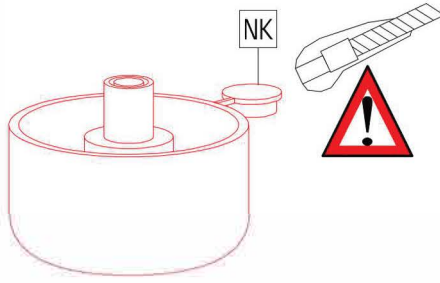
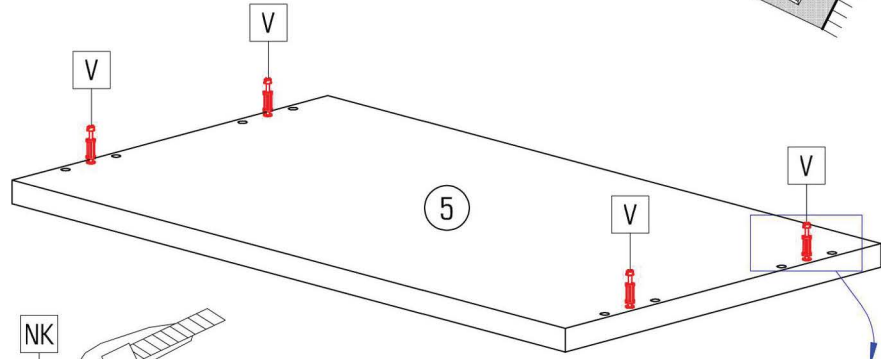
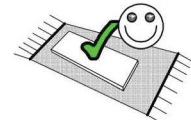

2/6 KLODEKAS 1

	$\varnothing 50 v=28$		
N	4x	V	8x

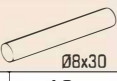

KLODEKAS 1 3/6

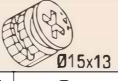
		
L 16x	M 16x	U 8x

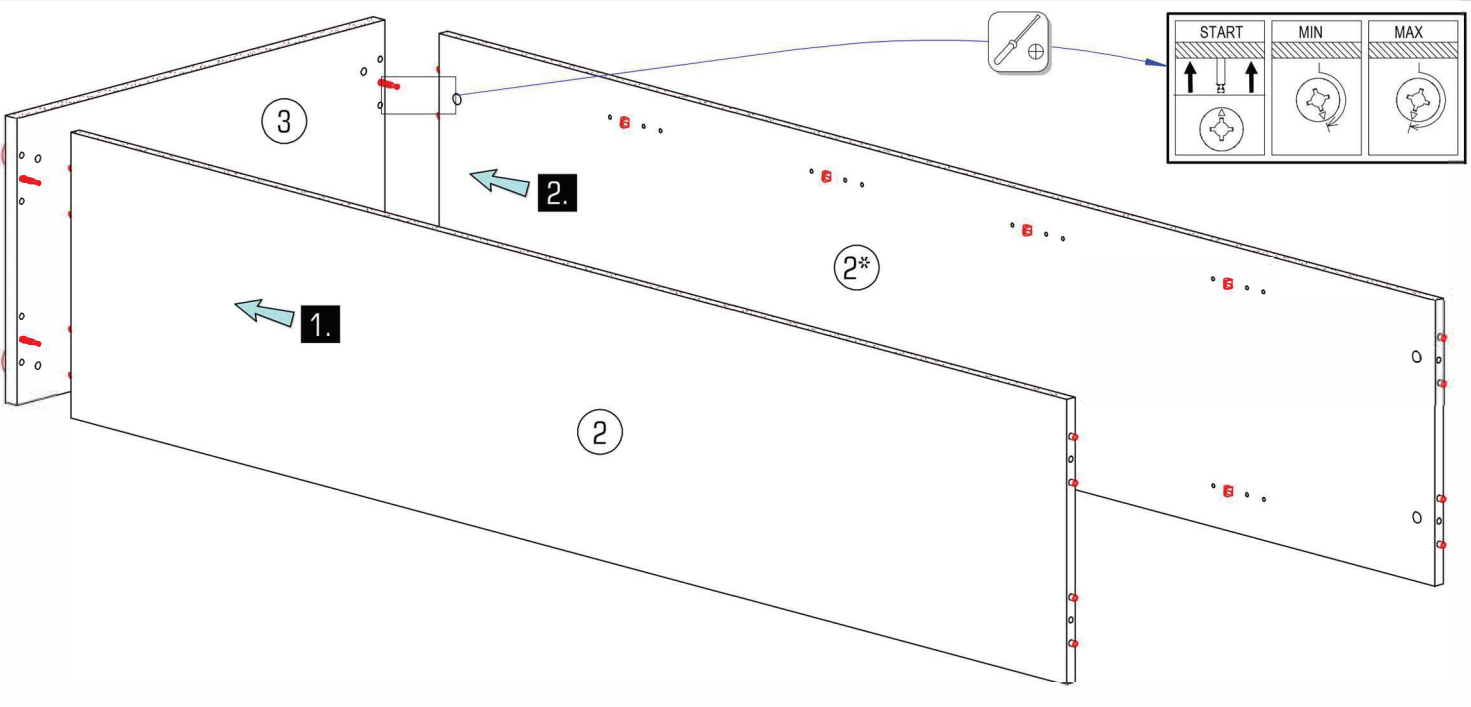
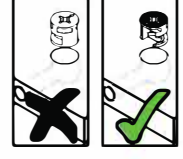
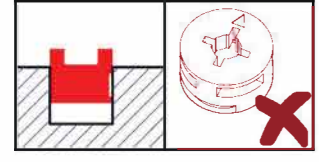
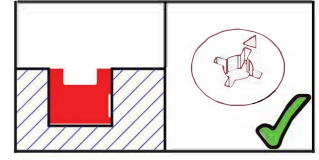
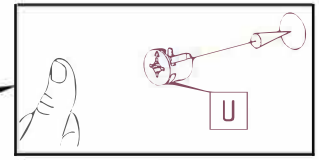
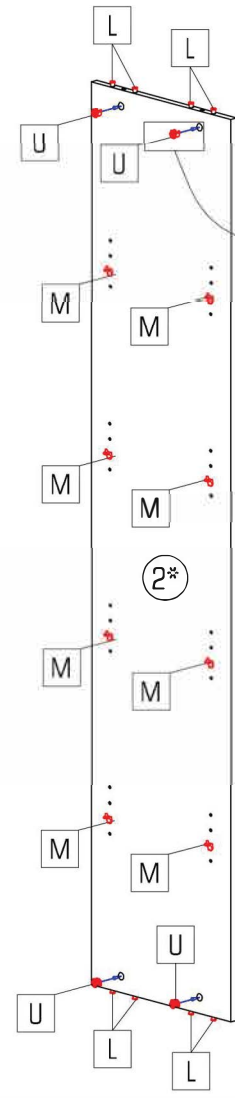
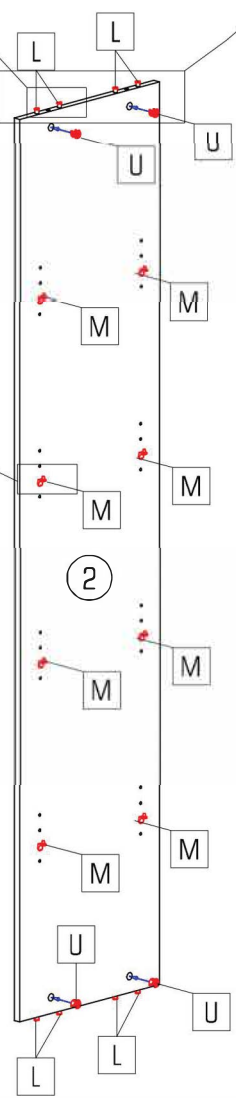
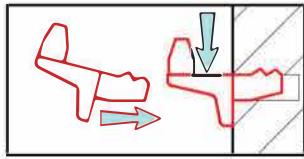
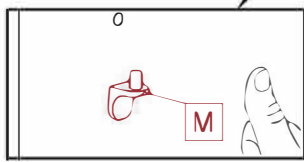
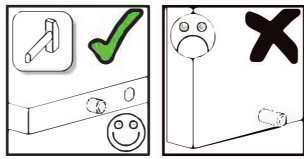
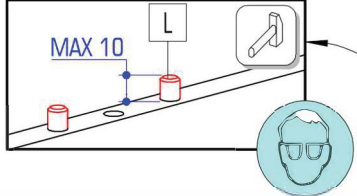
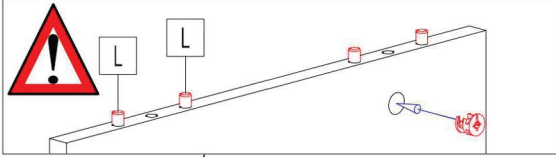



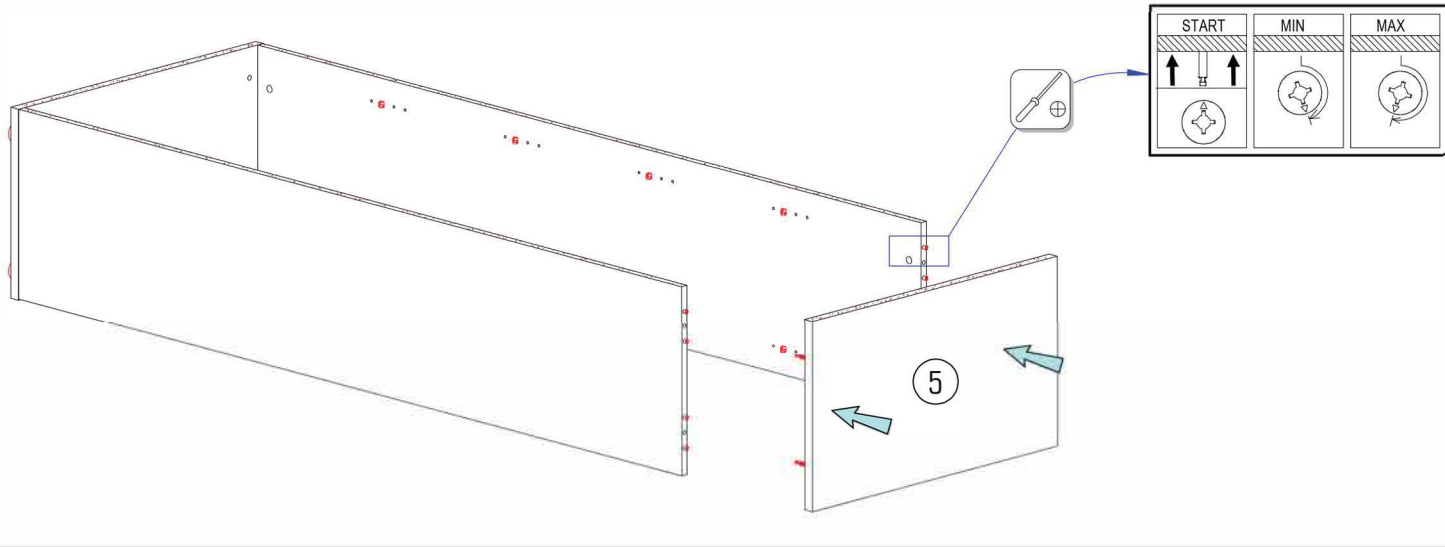

4/6 KLODEKAS 1

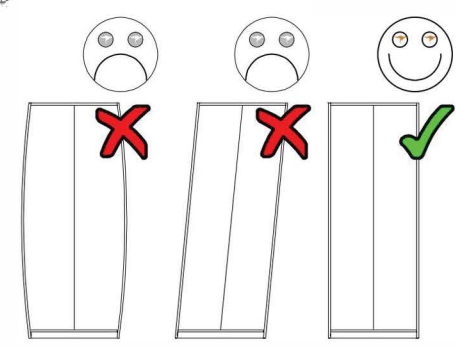
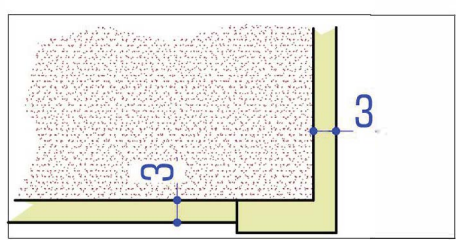
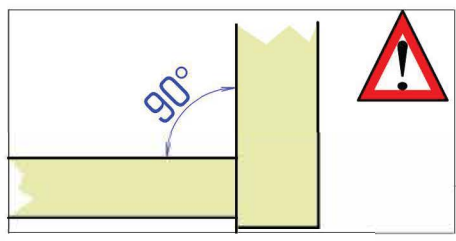
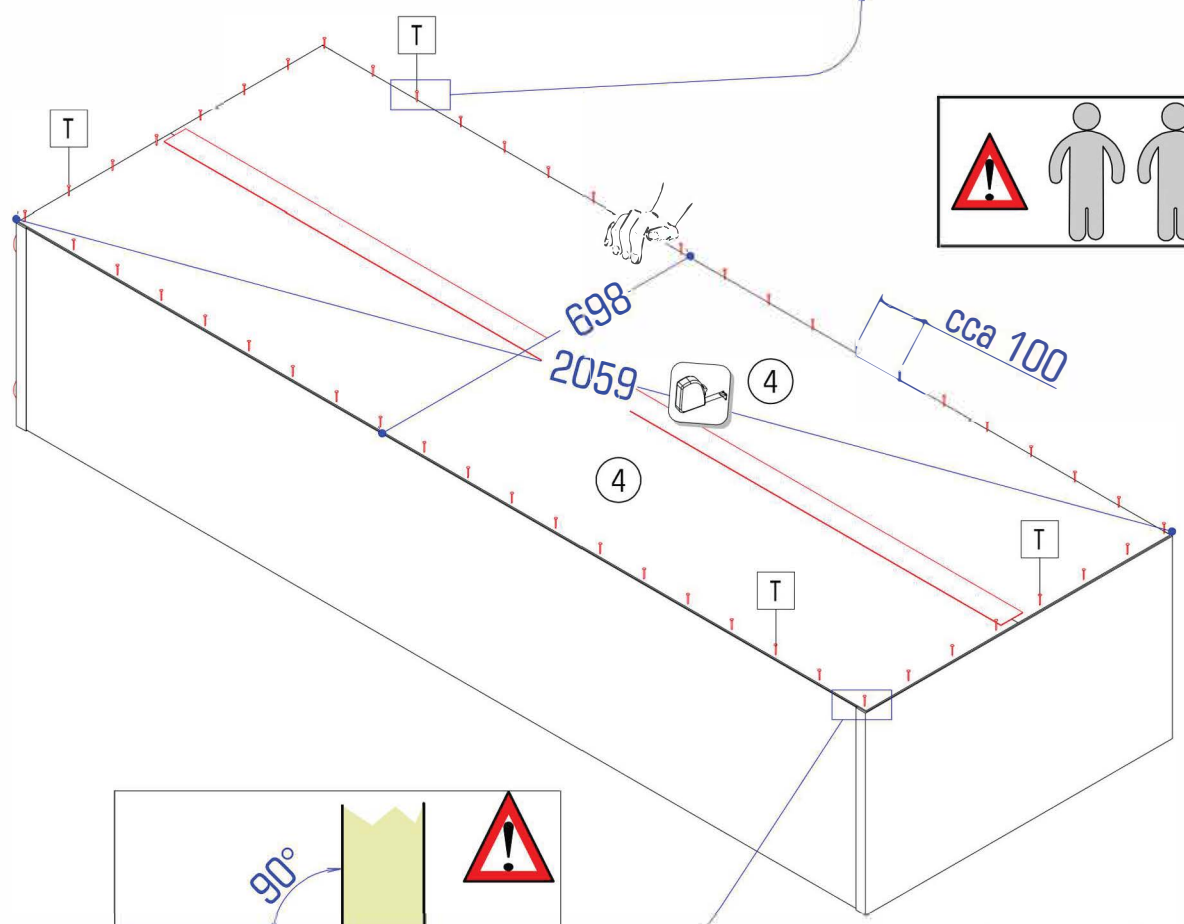
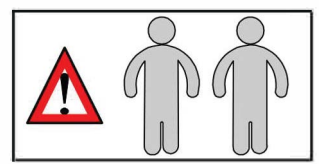
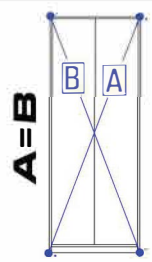
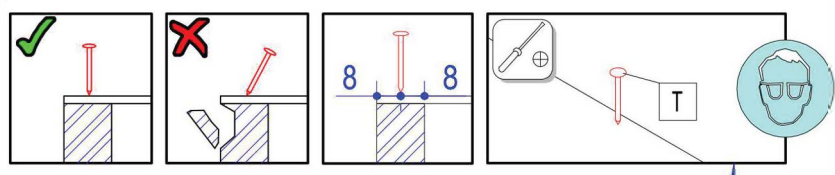

Ø1,6x20
T 75x



			
B 1x	E 2x	K 1x	P 1x

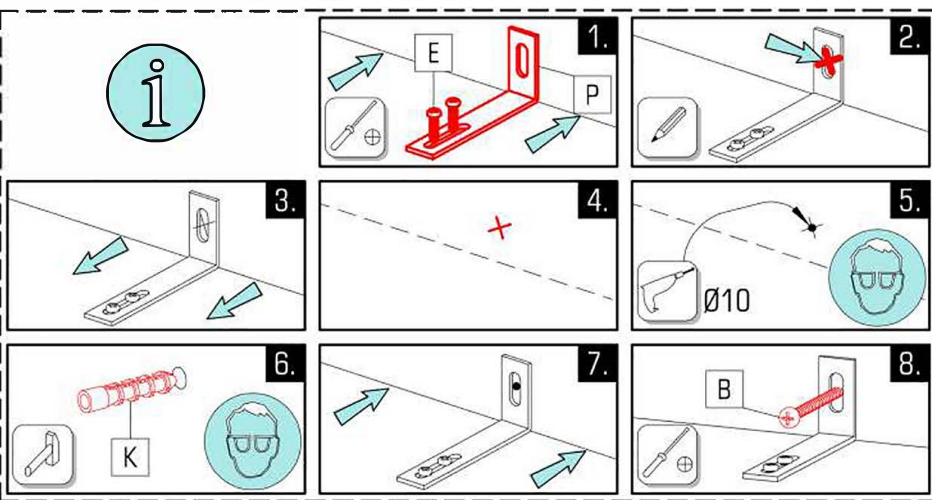
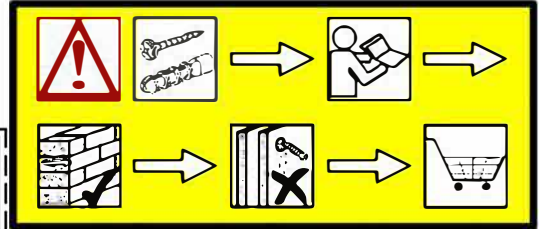

Caution! The wall must be examined before assembly. The included universal wall plugs are only suitable for using in firm masonry such as concrete block or brick. Do not use the wall plugs masonry such as hollow brick, lightweight block, surfaces such as gypsum plasterboard or other framing systems. If applicable, particular wall plugs must be used! These are available at a specialised store (hardware store). In case of non-compliance, the manufacturer/retailer or importer do not assume liability.

Upozornenie! Pevnosť steny sa musí pred montážou bezpodmienečne skontrolovať. Priložené univerzálne hmoždenky používajte jedine pre pevné murivo ako je betón/tehla. Hmoždenky sa nesmú používať v prípade ľahkého stavebného muriva, dutá tehla, Sádrokartónová doska, alebo iných konštrukcií rámu. U týchto stien je nutné použiť špeciálne hmoždenky! Tieto je možné dostať v špeciálnych predajniach so stavebným materiálom. Pri nedodržaní pokynov nepreberajú výrobcovia/predajci a dodávateľa zodpovednosť za vzniknuté škody.

Upozornění! Před montáží je nutné zkontrolovat stav stěny. Přiložené univerzální hmoždinky jsou určeny pouze k použití pro pevné zdivo jako beton/cihly. Hmoždinky do zdi se nesmí používat u dutinová cihla, zdiva jako pórovitý stavební kámen, sádkokartónová deska nebo jiný měkký materiál. U těchto zdív jsou nutné použít speciální hmoždinky! Jsou k dostání v speciálních prodejnách se stavebním materiálem. Při nedodržení těchto pokynů výrobce/prodejece a dovezce neručí za způsobené škody.

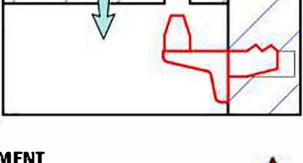
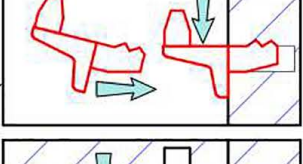
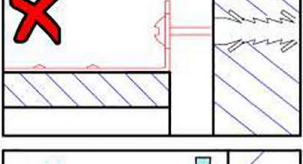
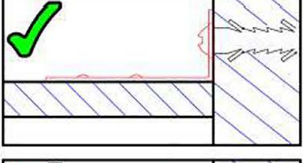
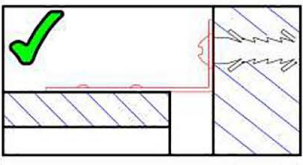
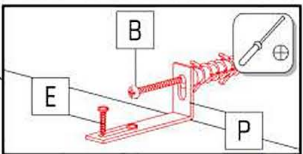
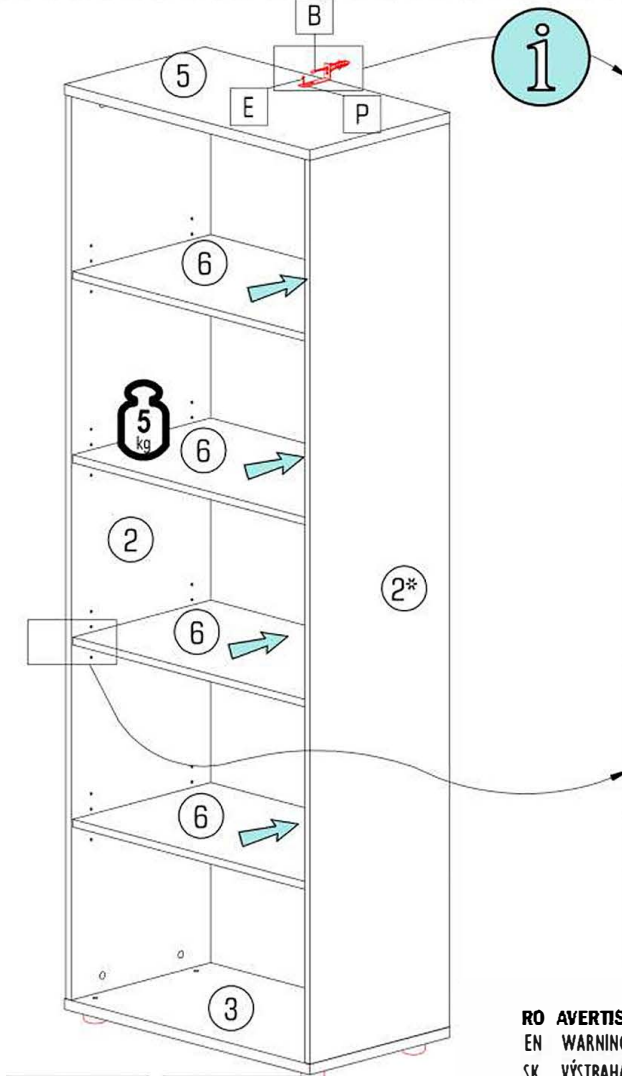

Paňja! Prije montaže obvezno provjerite svojstvo zida. Priložene univerzalne tiplje namijenjene su isključivo za masivne zidove od betona/opeke. Tiplje za masivne zidove ne smiju se koristiti za zidove kao npr. supljina opeka laki sastavni elementi, gips-kartonske ploče ili drugi modularni načini gradnje. Za te zidove potrebne su eventualno specijalne tiplje! Iste su dostupne u specijaliziranim trgovinama građevinskim materijalom. U slučaju nepridržavanja prethodno navedenih napomena, proizvođač/trgovac i uvoznik ne preuzimaju odgovornost!

Achtung! Die Wandbeschaffenheit ist vor der Montage unbedingt zu prüfen. Die beigelegten Universaldübel sind ausschließlich nur zur Verwendung für festes Mauerwerk wie Beton/Ziegel. Die Mauerdübel dürfen nicht bei Mauerwerk wie Hohlraumziegel, Leichtbausteinen, Gipskartonplatte oder anderer Rahmenbauweise verwendet werden. Bei diesen Mauerwerken sind gegebenenfalls Spezialdübel zu verwenden! Diese sind in einem Fachgeschäft erhältlich. Bei Nichteinhaltung wird seitens Produzenten/Händler und Importeur keine Haftung übernommen.

Vigyázat! Szerelés előtt a falfelület felületén vizsgálja meg. A mellékelt univerzális tiplje kizárólag stabil falazathoz használható mint például beton/égla. A fali tiplje nem használható könnyű építőkövekhez, üreg téglá, gipszkarton lapokhoz vagy más falfazás építményekhez. Ezekhez a falfelületekhez csak speciális tiplik használhatóak, melyek szaküzletekben (barkácsruházakban) beszerezhetőek. Fentiek figyelmen kívül hagyása esetén a gyártó/kereskedő vagy forgalmazó nem vállal felelősséget.

Prudență! Zidul trebuie examinat înainte de asamblare priza de perete de perete sunt adecvate numai pentru utilizarea în zidărie formă, cum ar fi betonul bloc sau cărămidă. Nu folosiți zidăria zidurilor de perete, cum ar fi cărămidă goală, blocul ușor, suprafețe cum ar fi gips-carton sau alți încadrare sisteme. Dacă este cazul, trebuie folosite anume tiplje de perete! Acestea sunt disponibile la un magazin specializat (magazin de hardware). În caz de nerespectare, producătorul / vânzătorul sau amănuntul sau importatorul nu își asumă răspunderea.

Uwaga! Ścianę należy sprawdzić przed montażem. Dołączone uniwersalne kołki rozporowe są odpowiednie tylko do stosowania w mocnych murach, takich jak beton lub cegła. Nie robć za pomocą kołków rozporowych murów, takich jak pustak, lekka kostka, powierzchnie takie jak płyty gipsowo-kartonowe lub inne systemy ram. Jeśli dotyczy, muszą to być określone kołki rozporowe być użytych! Są one dostępne w specjalistycznym sklepie niezgodności, producent / sprzedawca lub importer nie ponoszą odpowiedzialności.

Pozor! Pred montažu proverite stanje stene. Priloženi univerzalnici možniki se izključivo samo za uporabo na čvrstem zidovju, kot sta beton in opeka. Stenski možniki se ne smejo uporabljati pri zidovju kot so votline opeke, zidaki za lahko gradnjo, mavčne plošče ali druge okvirne gradnje. Pri teh zidovjih morate v danih primerih uporabljati posebno možnike. Ti so na voljo v specializiranih trgovinah (trgovinah z gradbenim materialom) Pri upoštevanju se s strani proizvajalca/trgovca in uvoznika ne prozva me jamstvo.

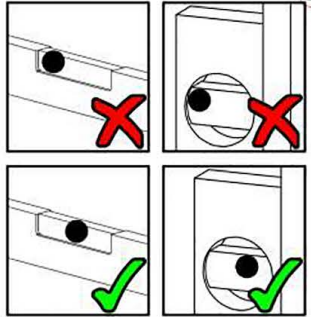

- RO AVERTISMENT
- EN WARNING
- SK VÝSTRAHA
- CZ VAROVÁNÍ
- HR UPOZORENJE
- DE WARNUNG
- HU FIGYELEM
- SE VARNING
- SI OPOZORILO
- PL OSTRZEŻENIE

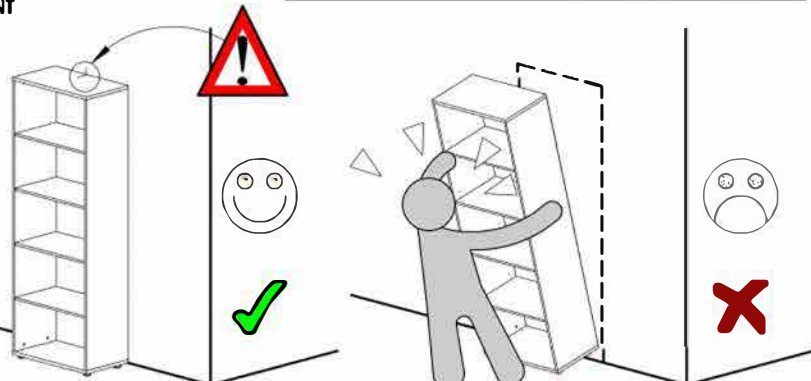

6/6 KLODEKAS 1

F 8x

