

MEUBLES
DEMEYERE

KARIBU 2-DVEROVÁ SKRIŇA 400080 0

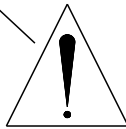

3H 00MN

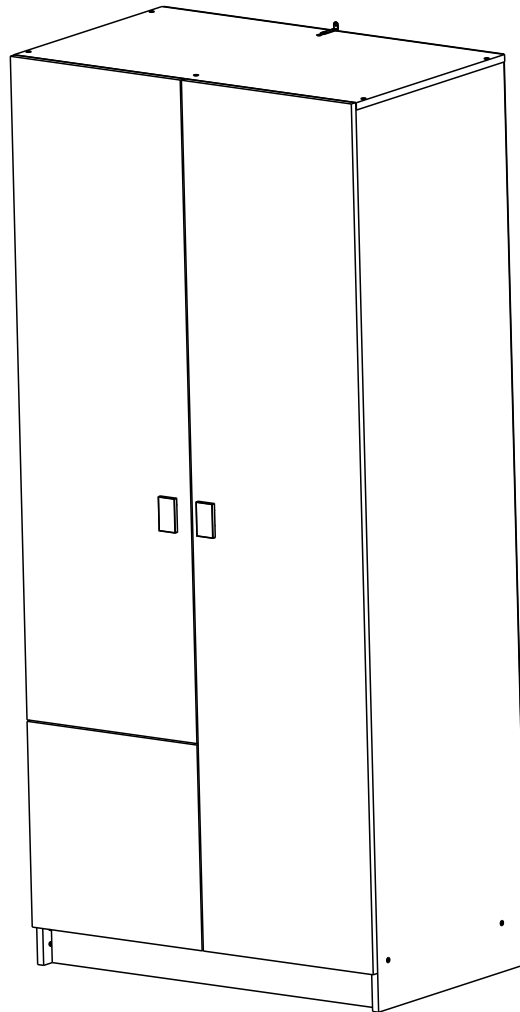
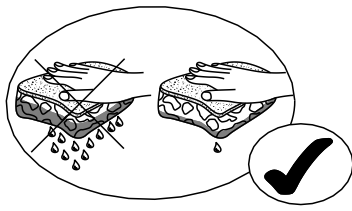
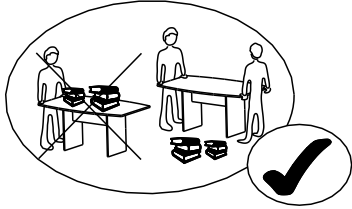
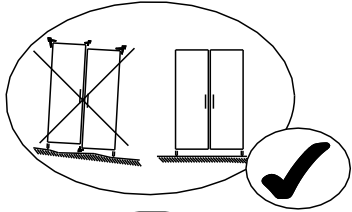
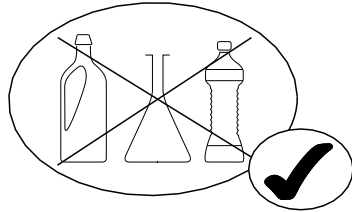
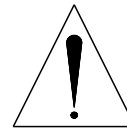

FR SECURITE

RESPECTER LES INSTRUCTIONS DE MONTAGE DECRITES DANS LA NOTICE.

EN CAUTION

FOLLOW CAREFULLY THE ASSEMBLING INSTRUCTIONS DESCRIBED IN THE DIRECTIONS.

DE SICHERHEITSVORSCHRIFTEN

BEACHTEN SIE BITTE UNBEDINGT DIE ANGEgebenEN AUFBAUVORSCHRIFTEN.

ES SEGURIDAD

RESPECTAR LAS INSTRUCCIONES DE MONTAJE DESCRIBIDAS EN EL FOLLETO.

NL VEILIGHEID

DE IN DE GEBRUIKSAANWIJZING BESCHREVEN INSTRUCTIES RESPECTEREN.

IT SICUREZZA

RISPETTARE LE INSTRUZIONI DI MONTAGGIO DESCRITTE NEEL'AVVERTENZA.

PT SEGURANCA

RESPECTAR AS INSTRUCOES DE MONTAGEM DESCRÉVIDAS NA INSTRUCCOES DE USO.

SK

PRI MONTÁŽI POSTUPOUJTE OPATRNĚ PODĹA MONTÁŽNEHO NÁVODU

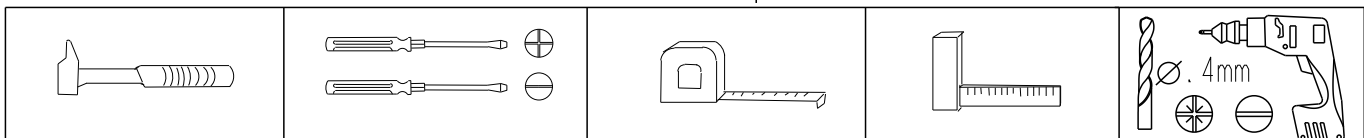

REP	DIM	QTE
1	1855 x 500	1
2	1855 x 500	1
3	853 x 501	1
4	819 x 499	1
5	819 x 91	1
6	1747 x 498	1
7	402 x 421	1
8	1790 x 423	1
9	1364 x 423	1
10	423 x 423	1
11	402 x 420	2
12	1776 x 847	1

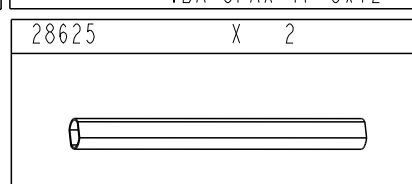
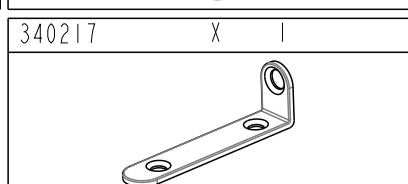
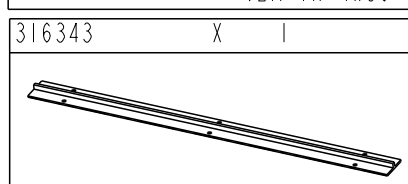
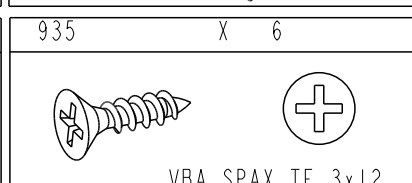
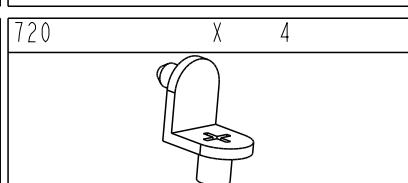
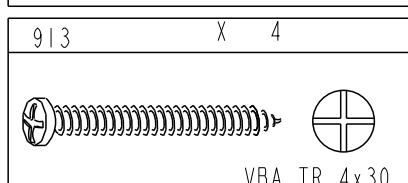
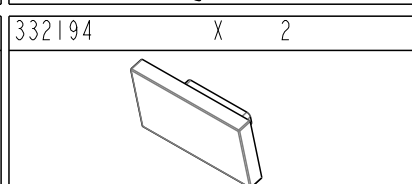
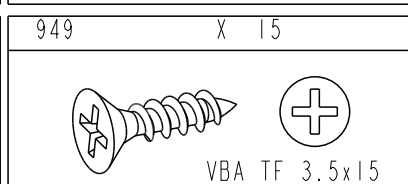
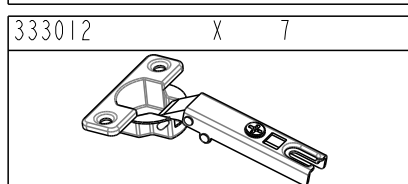
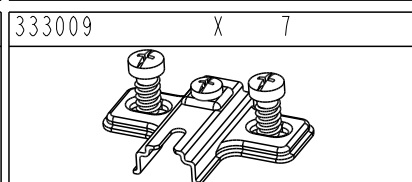
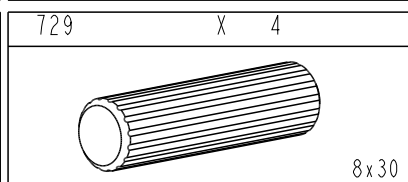
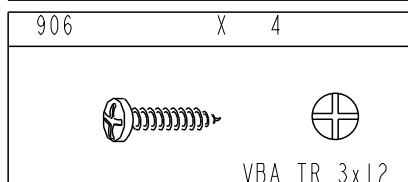
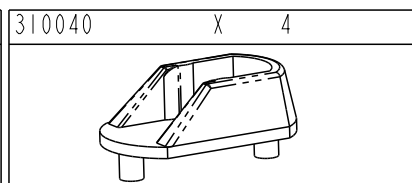
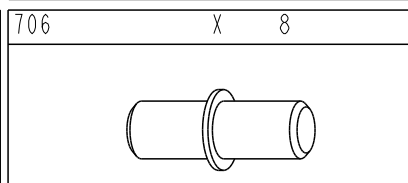
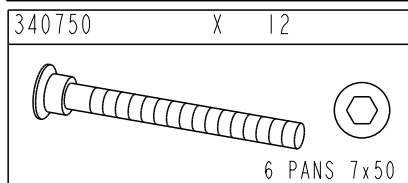
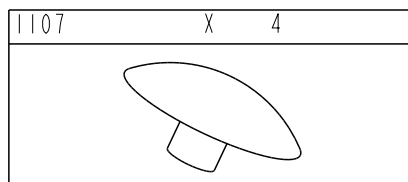
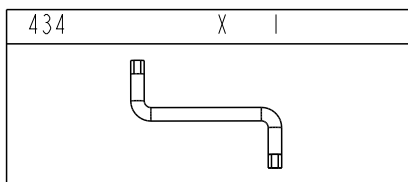
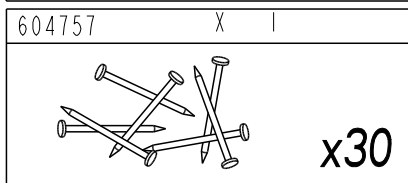
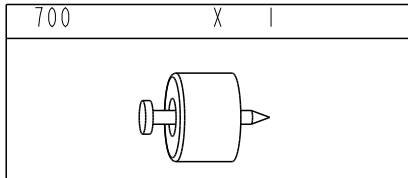
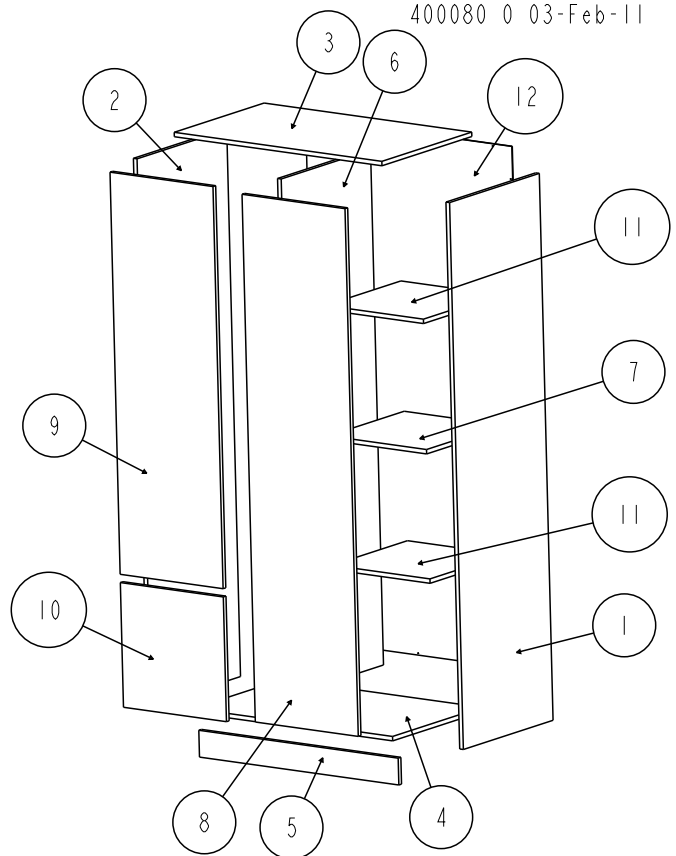

4

333009

X 7

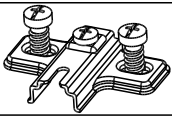

720

X 2



310040

X 2

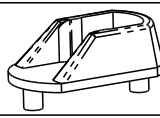

400080 0 03-Feb-11

906

X 2

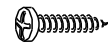

VBA TR 3x12

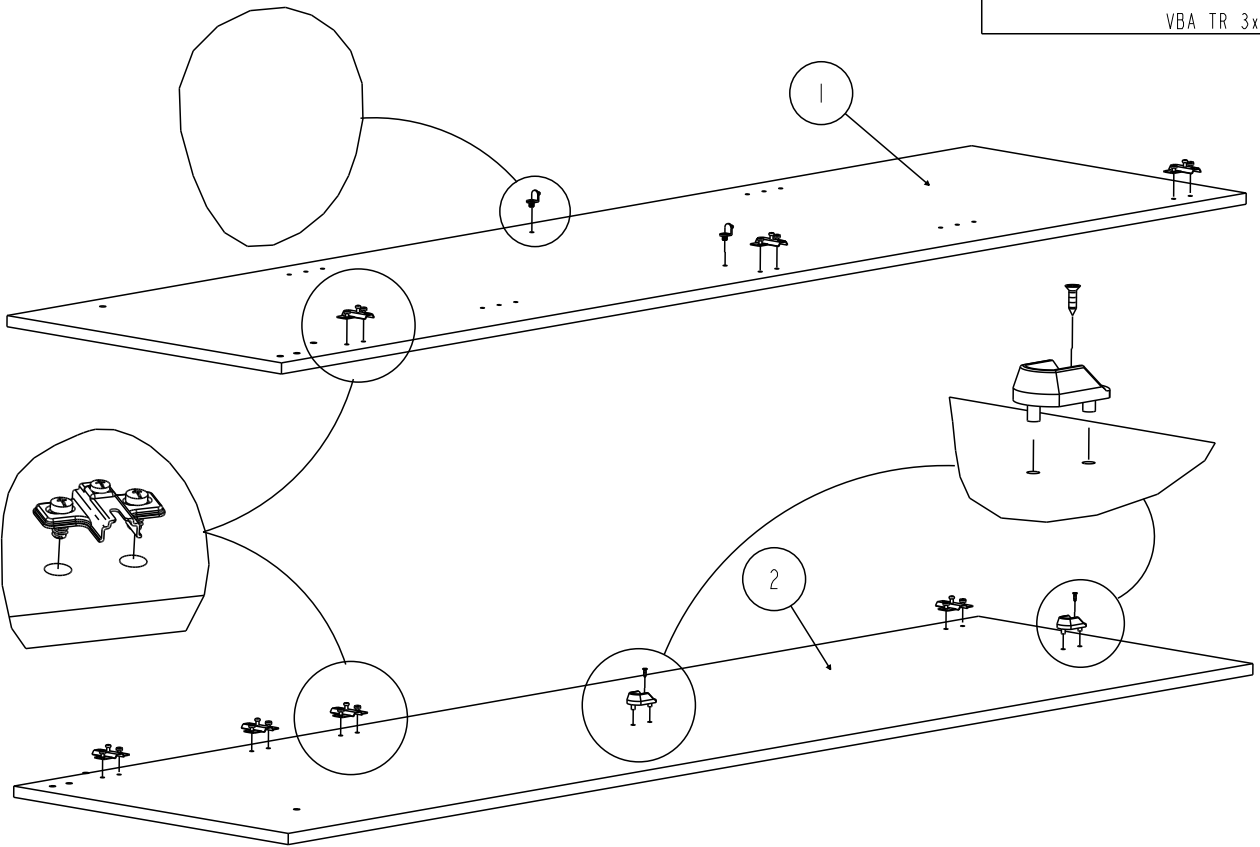

5

340750

X 4

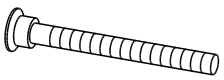

6 PANS 7x50

434

X 1

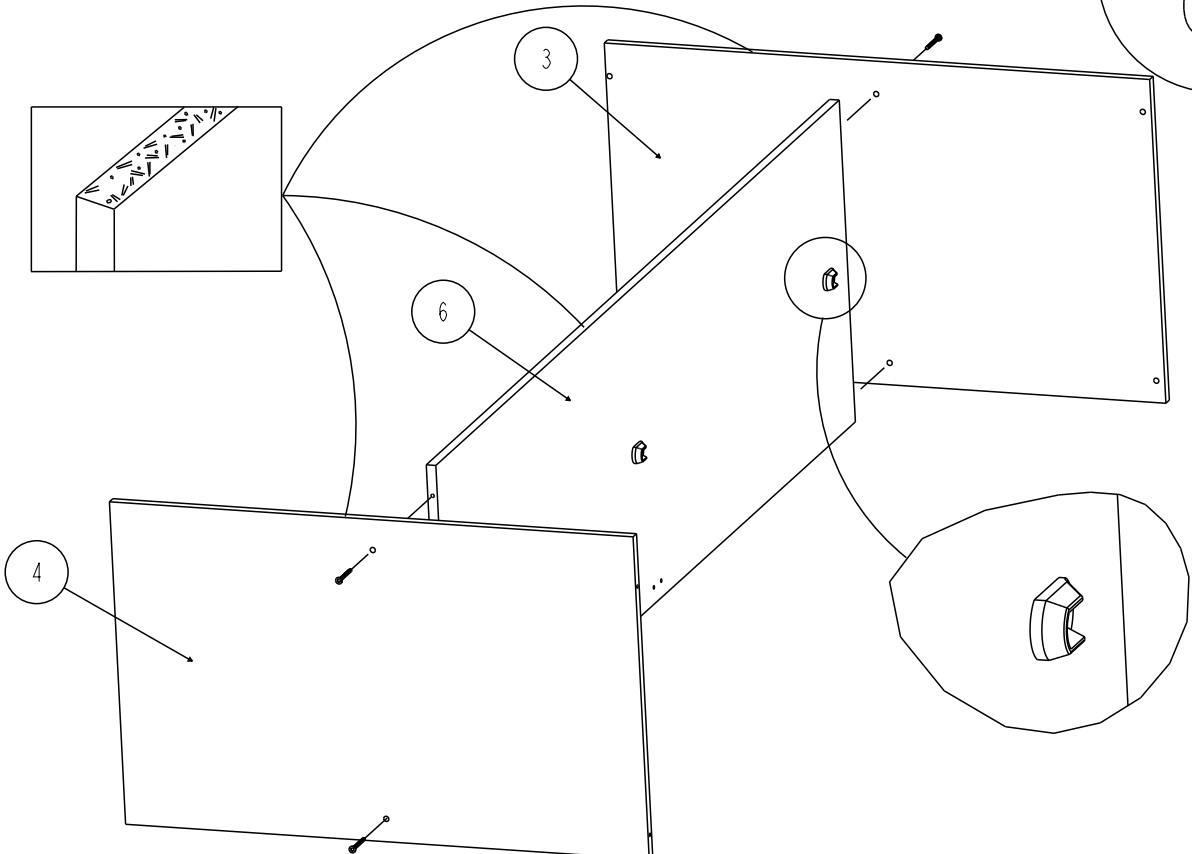
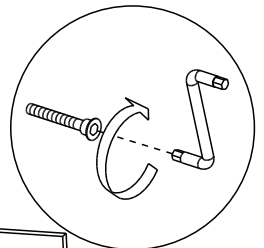
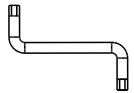

ECH

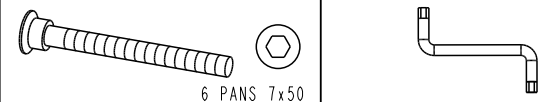

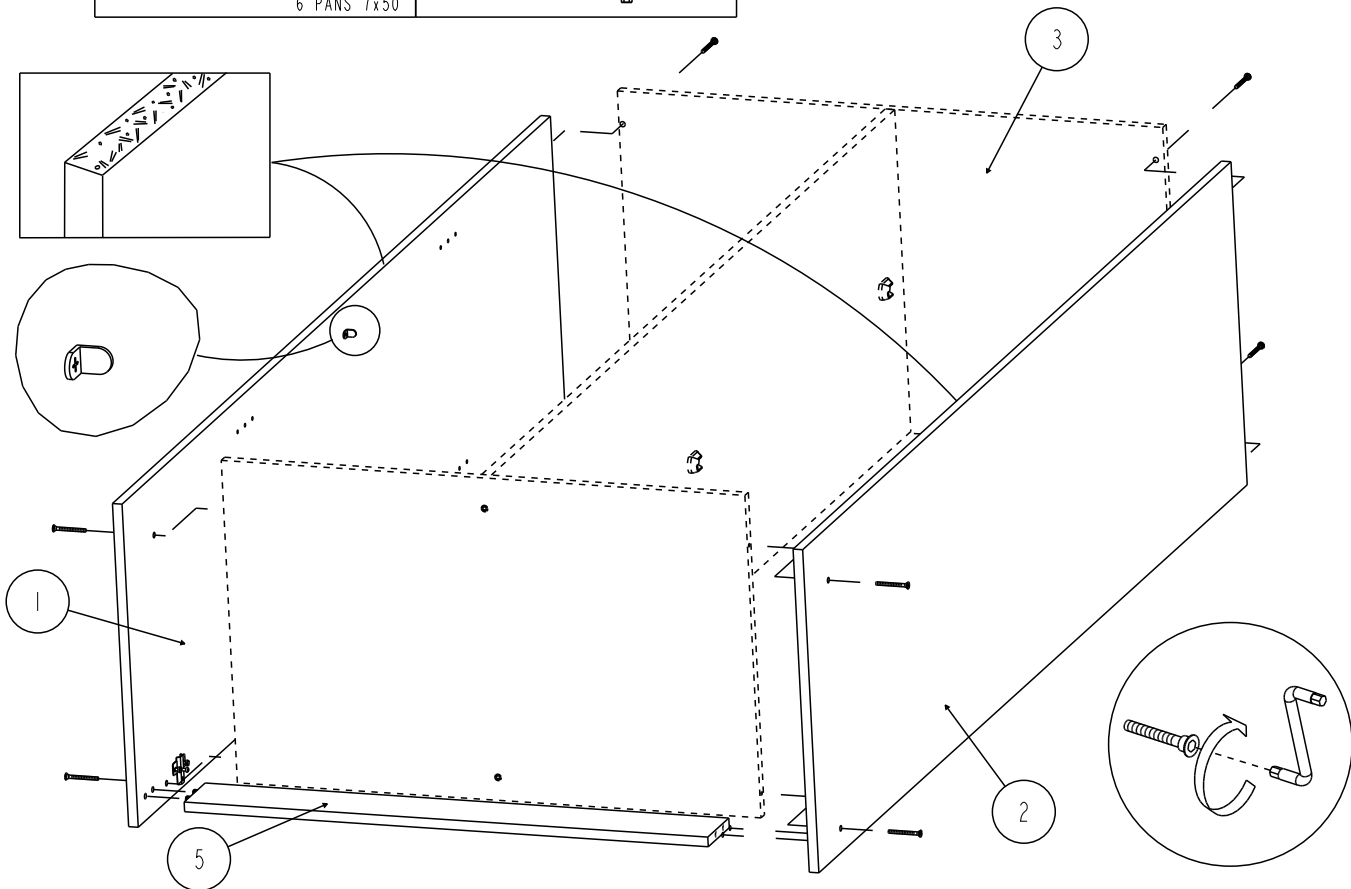
6	340750	X 8	434	X 1
	 6 PANS 7x50			

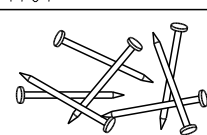

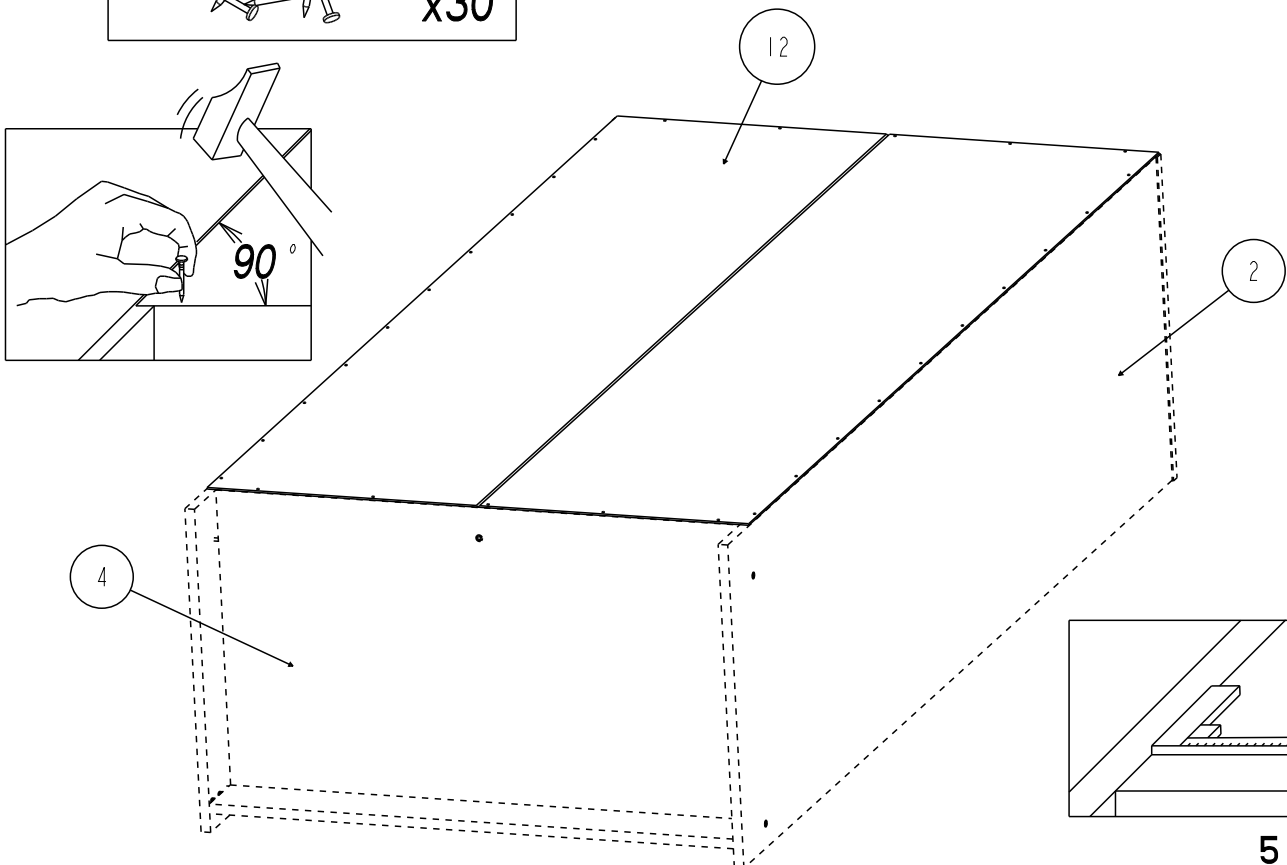
7	604757	X 1
	 x30	

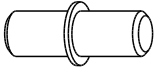

8

706	X 8	720	X 2	28625	X 2
					

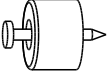

400080 0 03-Feb-11

1107	X 4
	

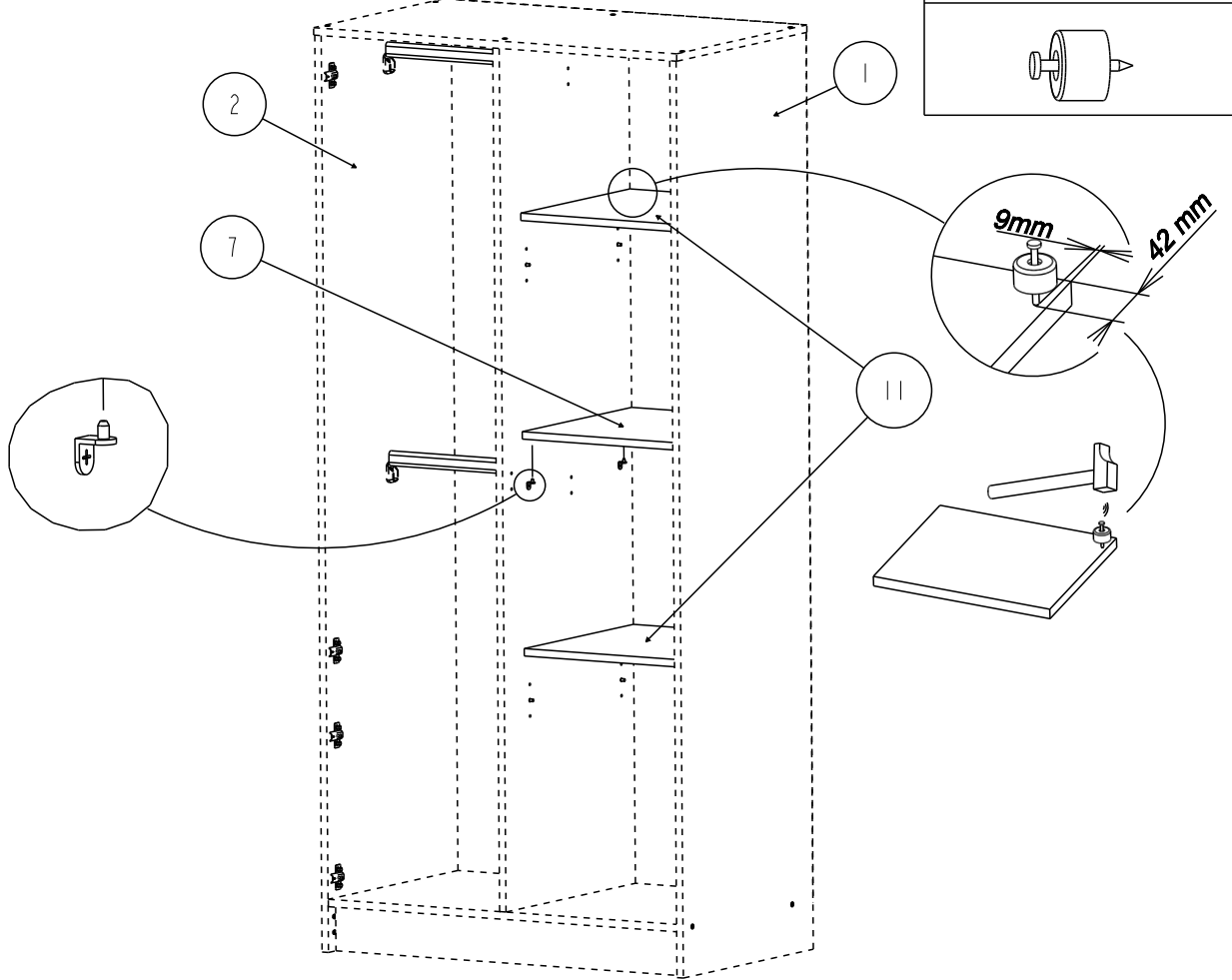
700	X 1
	



9

316343	X 1	935	X 6
		 	
VBA SPAX TF 3x12			

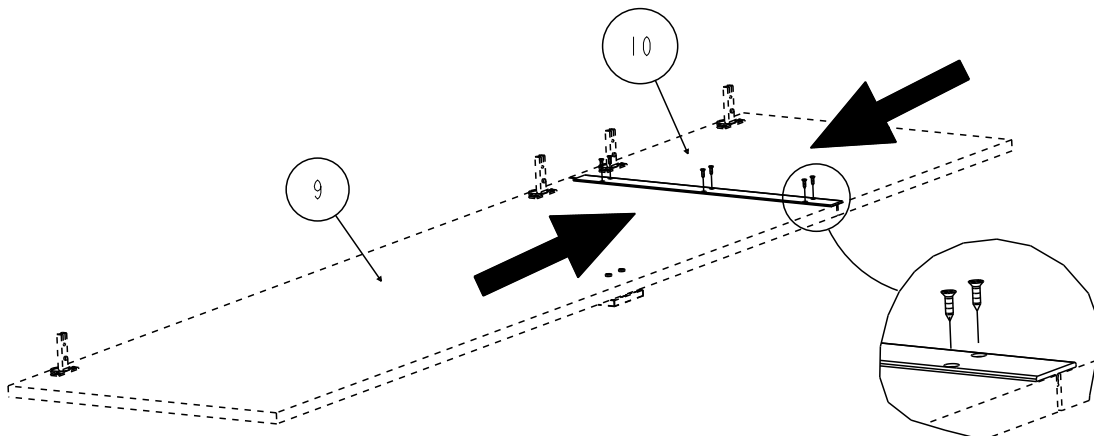

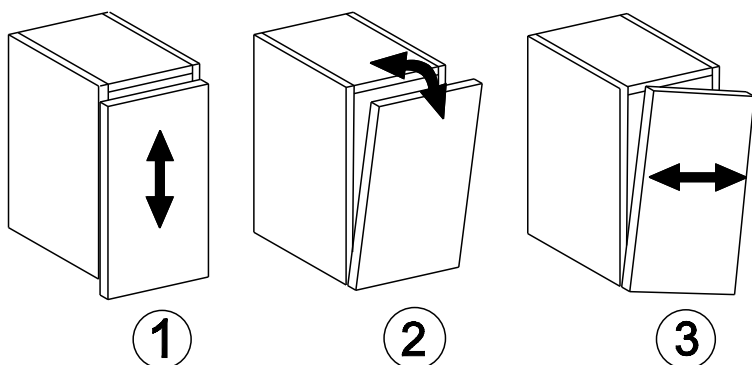
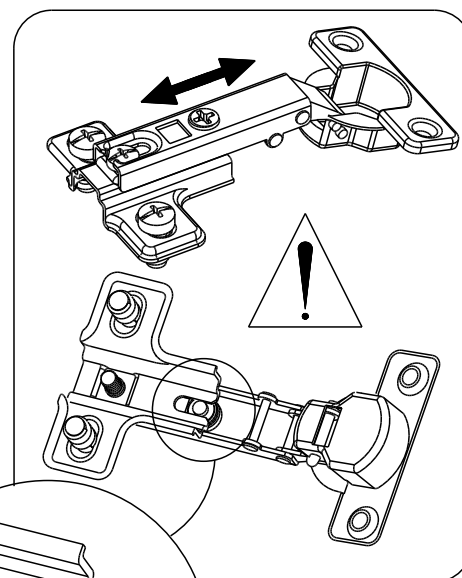
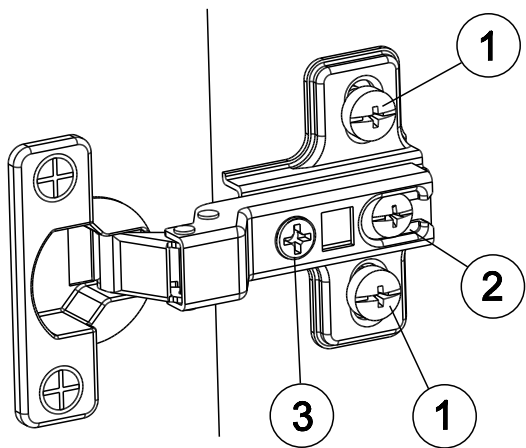
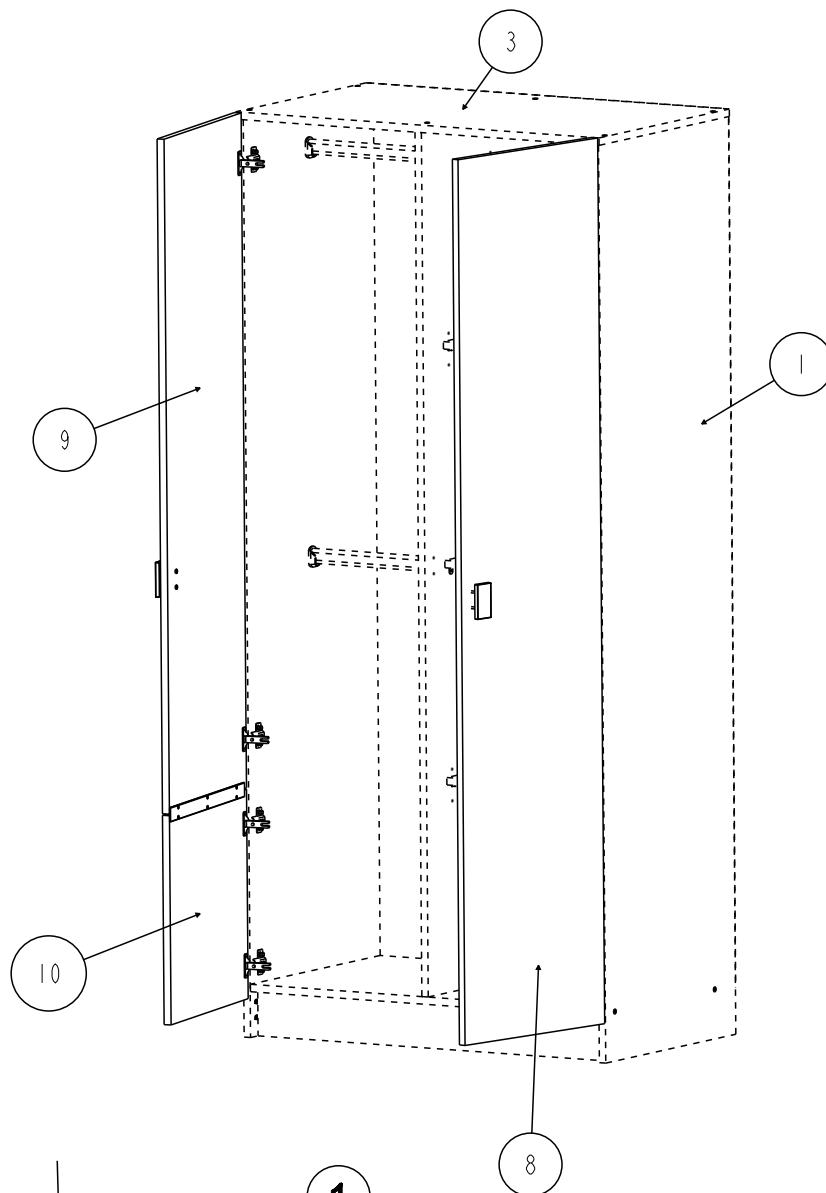

11

340217

X

I

949

X

I

400080 0 03-Feb-11

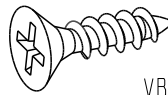
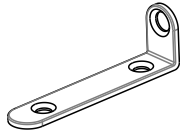

VBA TF 3.5x15

FR MEUBLES A FIXER AU MUR:

- FIXER LE MEUBLE AU MUR AVEC LES ATTACHES PREVUES A CET EFFET
- VERIFIER QUE LES VIS ET LES CHEVILLES UTILISEES SONT ADAPTEES AU SUPPORT

ES MUEBLES A FIJAR EN LA PARED:

- FIJAR EL MUEBLE EN LA PARED CON LAS GRAPAS PREVISTAS
- COMPROBAR QUE LOS TORNILLOS Y LAS CLAVIJAS UTILIZADAS SON ADAPTADAS AL SOPORTE

PT MOVEIS A FIXAR NA PAREDE:

- FIXAR O MOVEL NA PAREDE COM OS PRENDES PREVISTOS
- VERIFICAR QUE OS PARAFUSOS E AS CAVILHAS UTILIZADOS SAO ADAPTADOS OA SUPORTE

EN FURNITURES TO BE HOLD ON THE WALL:

- HOLD THE FURNITURE ON THE WALL WITH THE FASTENINGS PROVIDED FOR THIS PURPOSE
- CHECK THAT THE SCREW AND PEGS FIT WITH THE SUPPORT

IT MOBILI DA FISSARE AL MURO:

- FISSARE IL MOBILE AL MURO CON LE FLANGIE PREVISTE A TALE SCOPO
- VERIFICARE CHE LE VITI ED I PERNI USATI SIANO ADATTI A QUEL TIPO DI SUPPORTO

PL MEBEL PRZEZNACZONY DO ZAINSTALOWANIA NA ŚCIANIE:

- NALEŻY ZAMONTOWAC TEN MEBEL NA ŚCIANIE PRZEZNACZONYMI DO TEGO CELU UCHWYTAMI
- NALEŻY SPRAWDZIC CZY SRUBY I KOSZULKI SA ODPOWIEDNIEJ WIELKOSCI W STOSUNKU DO UCHWYTÓW

DE MOEBEL AN DER MAUER ZU BEFESTIGEN:

- BEFESTIGEN SIE DAS MOEBELSTUECK MIT DEN DAFUER VORGESEHENEN BEFESTIGUNGSHAKEN
- UEBERPRUEFEN SIE BITTE DASS DIE SCHRAUBEN UND DUEBEL MIT DEM MATERIAL DER MAUER UEBEREINSTIMMEN

SK SKRIŇA PRICHYTENÁ K STENE

- PRI UCHYTENÍ SRINE O STENU POUŽITÉ PRÍSLUŠNÉ UCHYTKY KTORÉ TOMU ZODPOVEDAJÚ
- SKONTORLUJTE ČI ŠRÓBY PEVNE ZAPADAJÚ DO PRÍSLUŠNÝCH ÚCHYTIEK

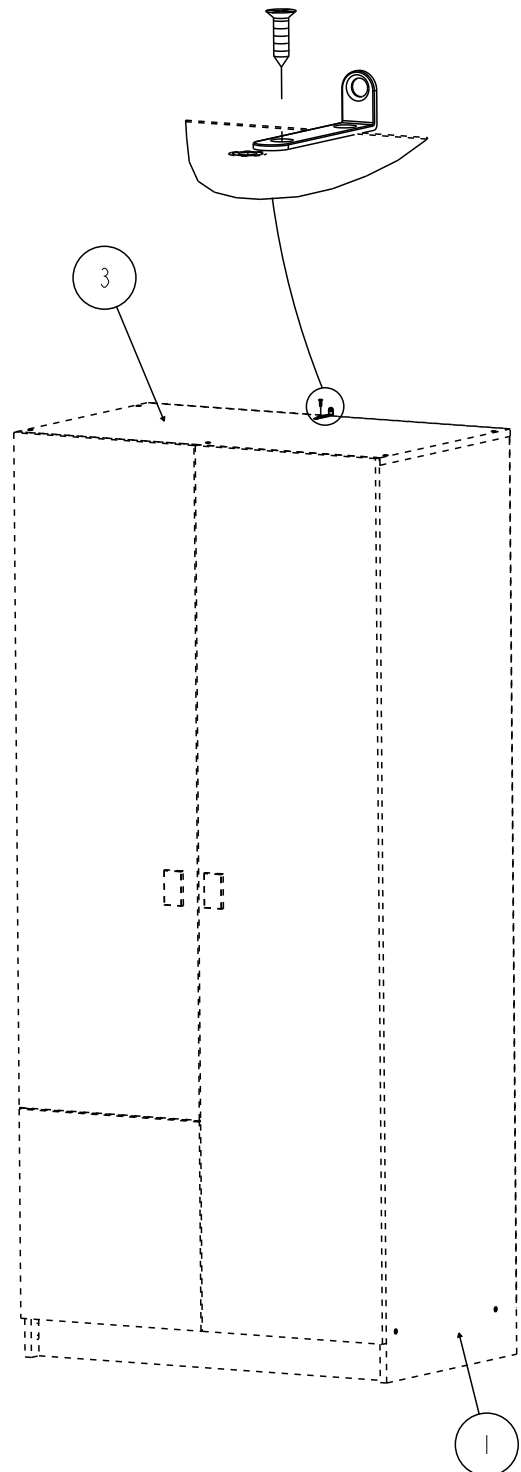

1

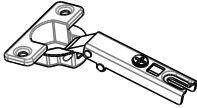
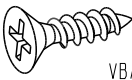
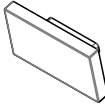

333012 X 7	949 X 14	332194 X 2
	 VBA TF 3.5x15	

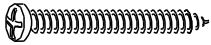
400080 0 03-Feb-11

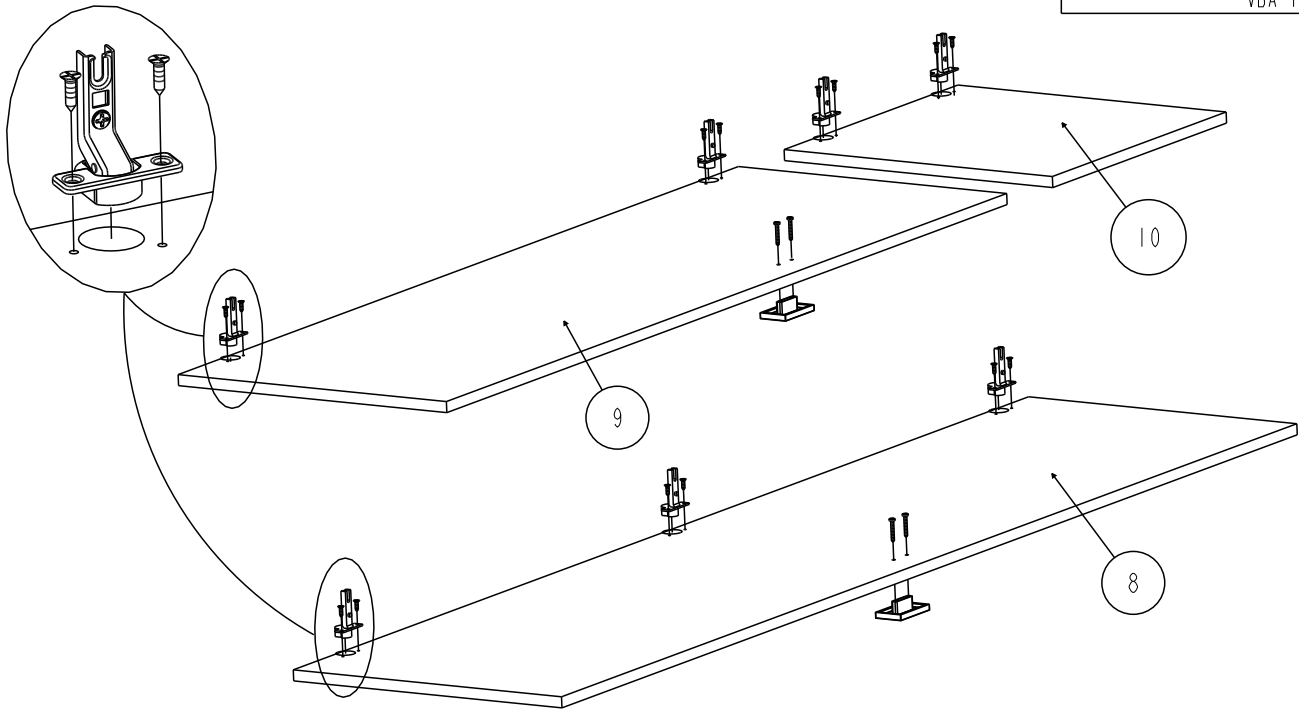
913 X 4
 VBA TR 4x30

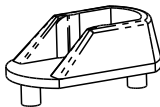

2

310040 X 2	906 X 2
	 VBA TR 3x12

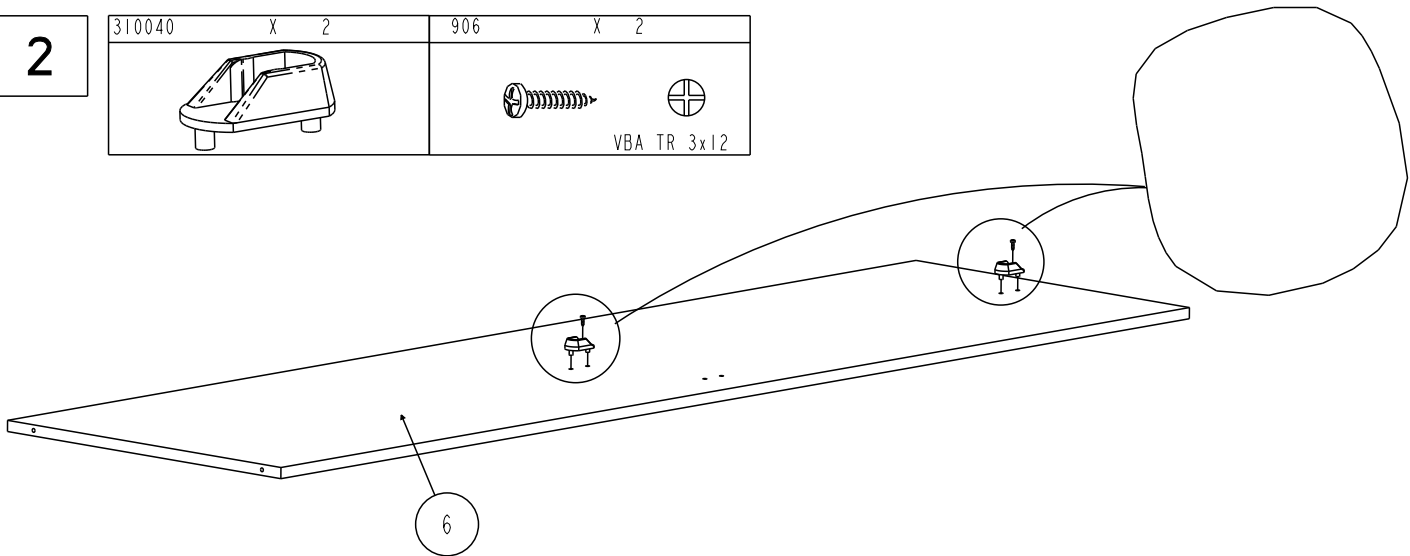

3

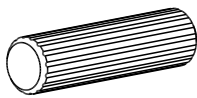
729 X 4
 8x30

