

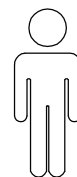

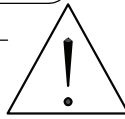

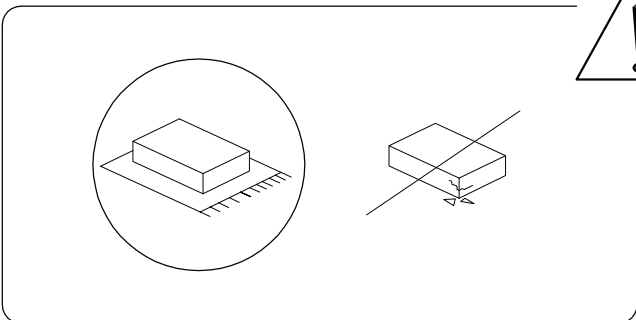

20'

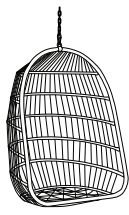
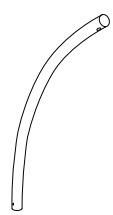

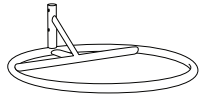
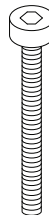
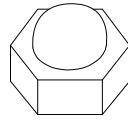
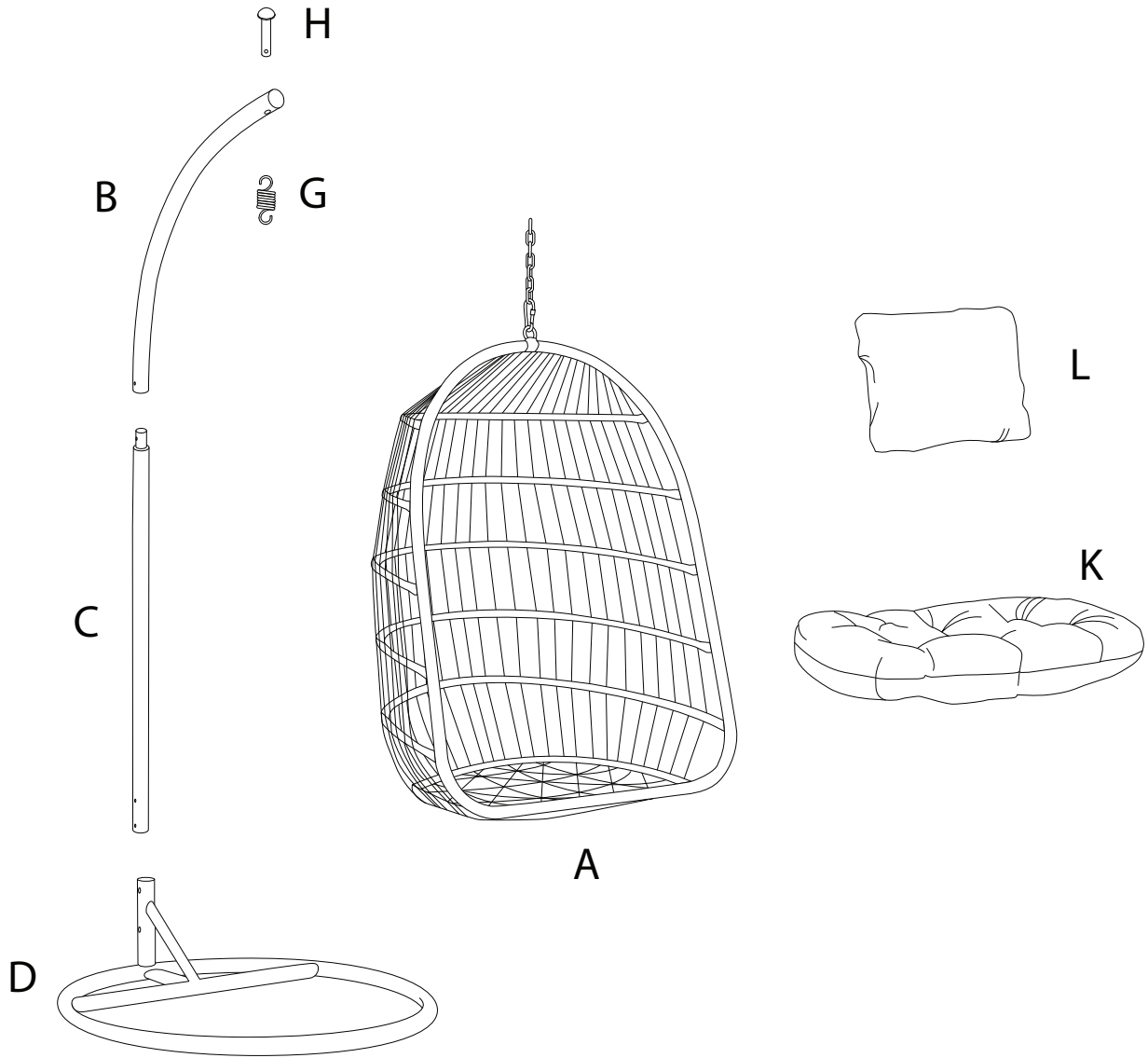
2

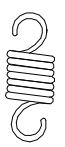
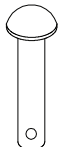
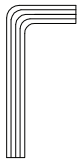
| | | | | | |
|---|---|---|--|---|---|
| <p>A</p>  <p>x 1</p> | <p>B</p>  <p>x 1</p> | <p>C</p>  <p>x 1</p> | <p>D</p>  <p>x 1</p> | <p>E</p>  <p>M10 x 60</p> <p>x 3</p> | <p>F</p>  <p>x 3</p> |
|---|---|---|--|---|---|



| | | | | | |
|---|---|---|---|---|---|
| <p>G</p>  <p>x 1</p> | <p>H</p>  <p>x 1</p> | <p>I</p>  <p>x 1</p> | <p>J</p>  <p>x 1</p> | <p>K</p>  <p>x 1</p> | <p>L</p>  <p>x 1</p> |
|---|---|---|---|---|---|

1

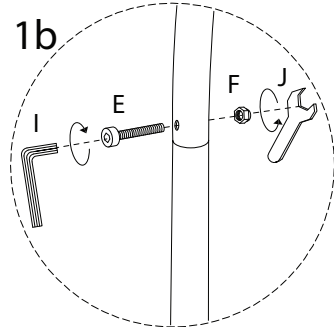
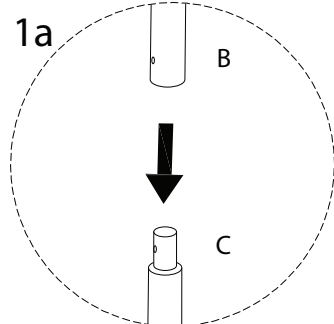
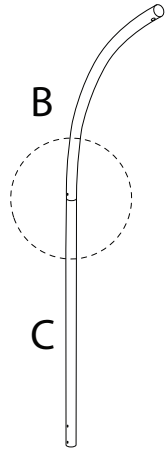
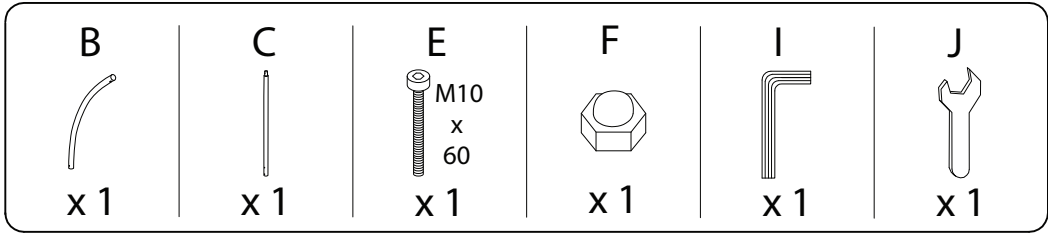

2

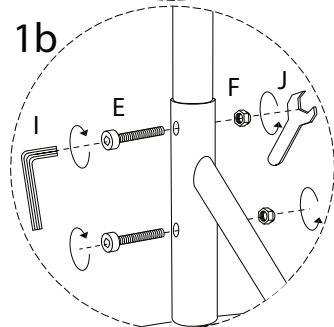
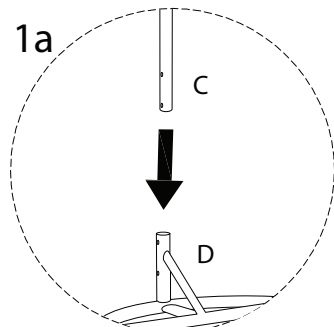
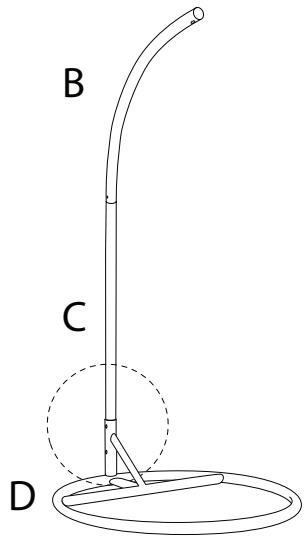
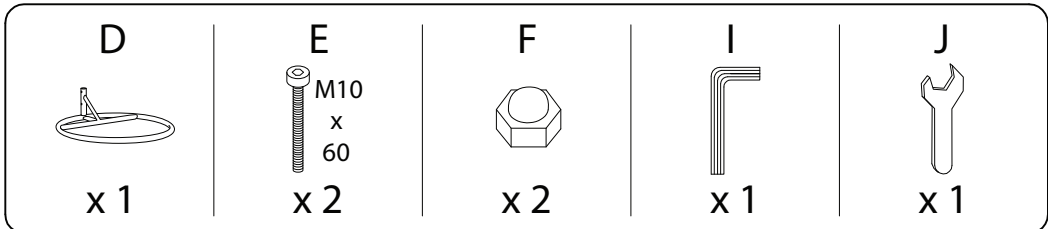

3

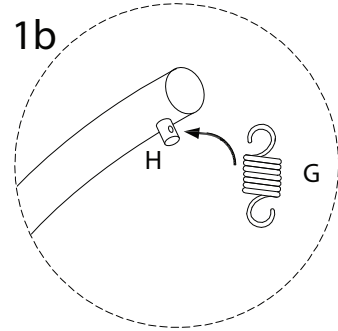
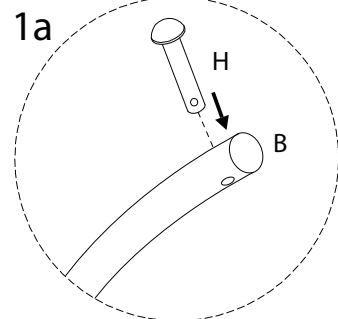
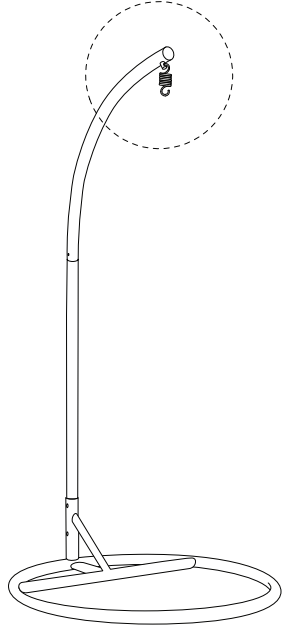
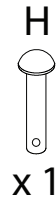

4

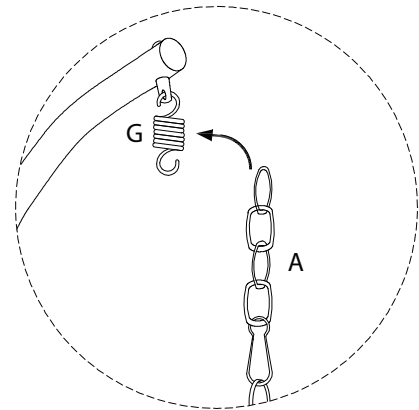
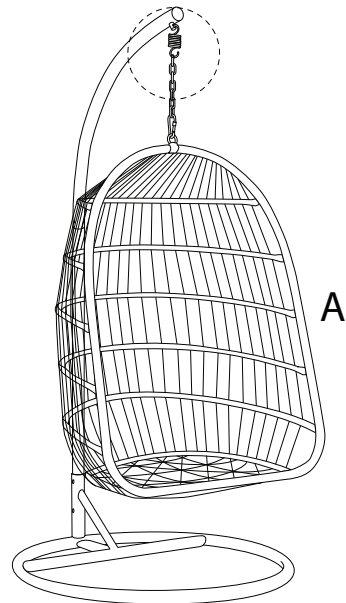

5

K



x 1

L



x 1

