	<p>20'</p>
		
		<p>1</p>

1/3

A

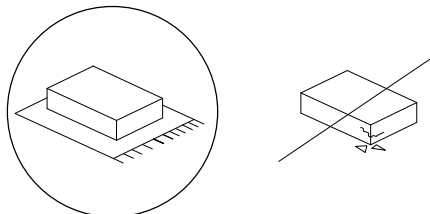
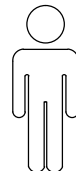
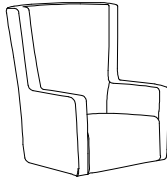

x 1

B



x 4

A

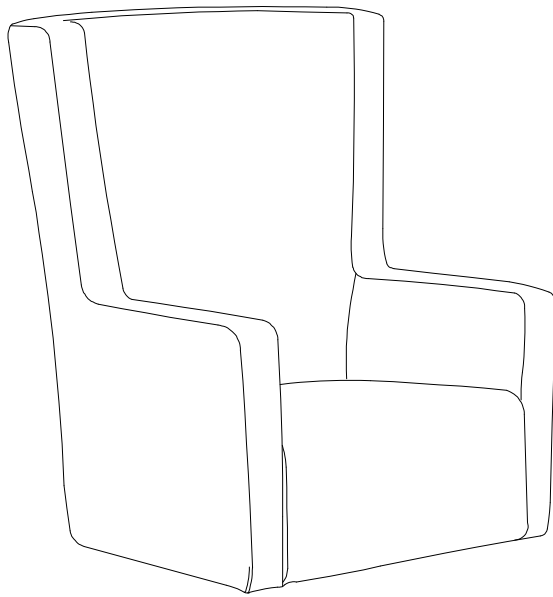

B x 4

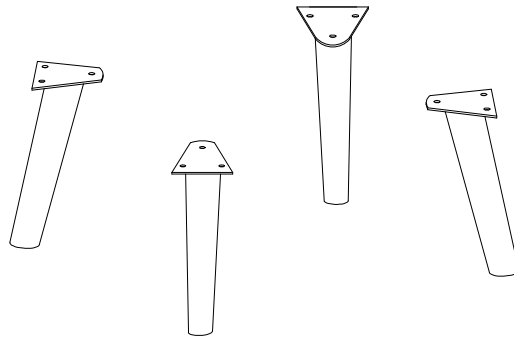

C

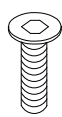

**M6
x
20**

x 12

D

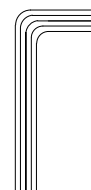

x 1

1

