

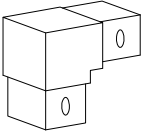

10'

1

1/5

<p>A</p>  <p>x 8</p>	<p>B</p>  <p>x 4</p>	<p>C</p>  <p>M6 x 34</p> <p>x 4</p>
---	---	--

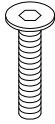
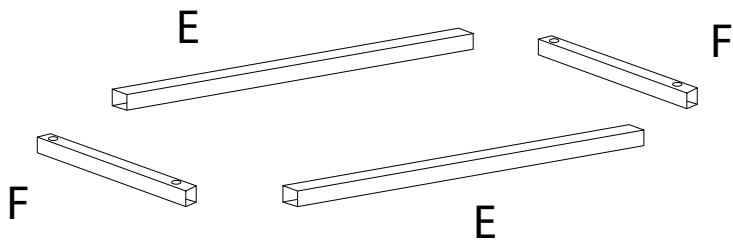
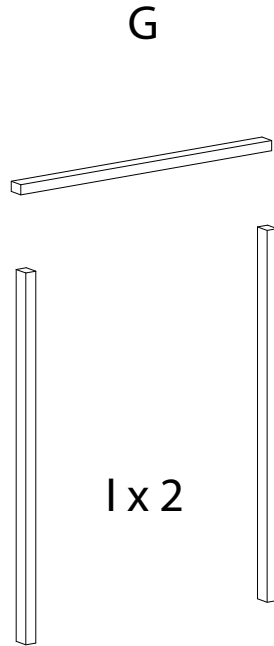
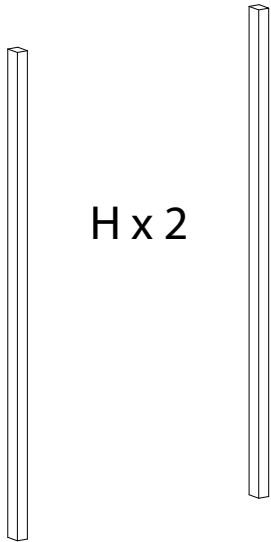
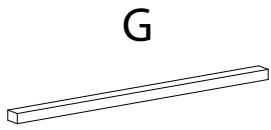

D



x 1

E



x 2

F

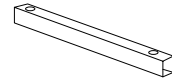

x 2

G

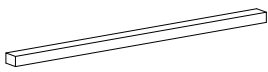

x 2

H



x 2

I



x 2

1

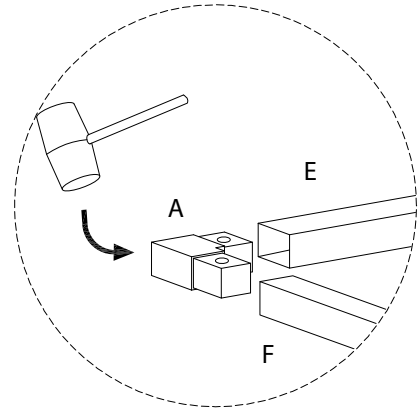
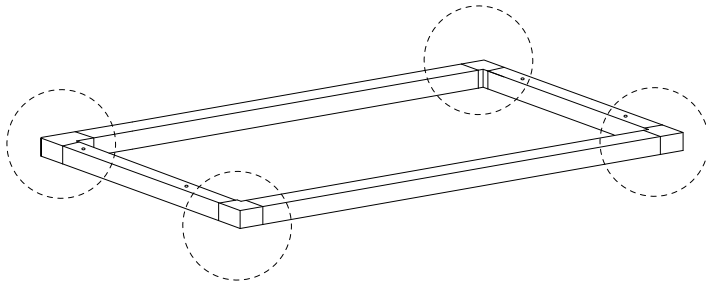
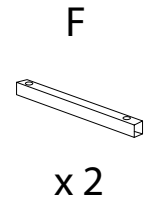
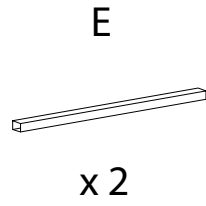
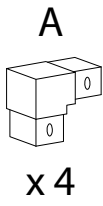

2

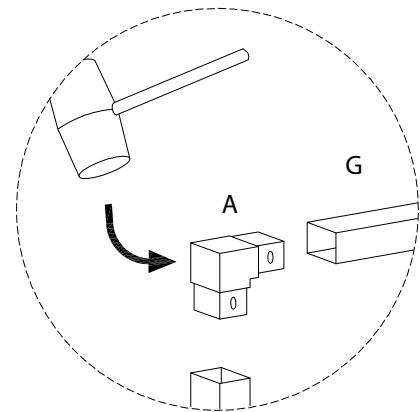
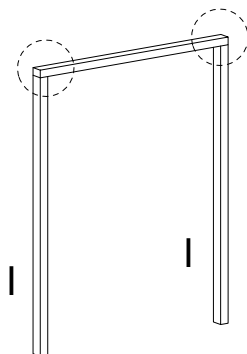
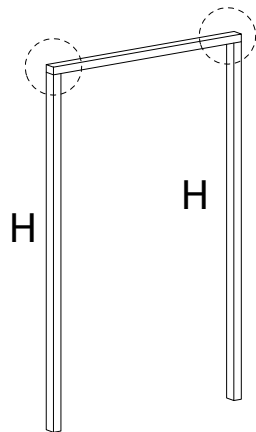
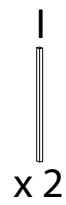
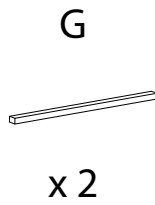
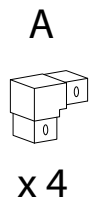

3

C



x 4

D

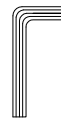

x 1

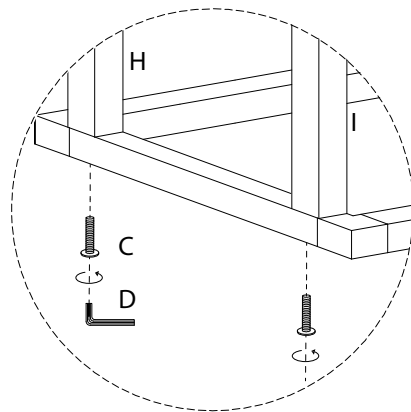
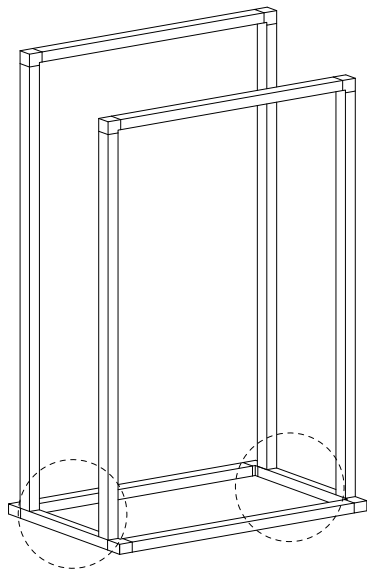

4

B



x 4

