

		45'
		1

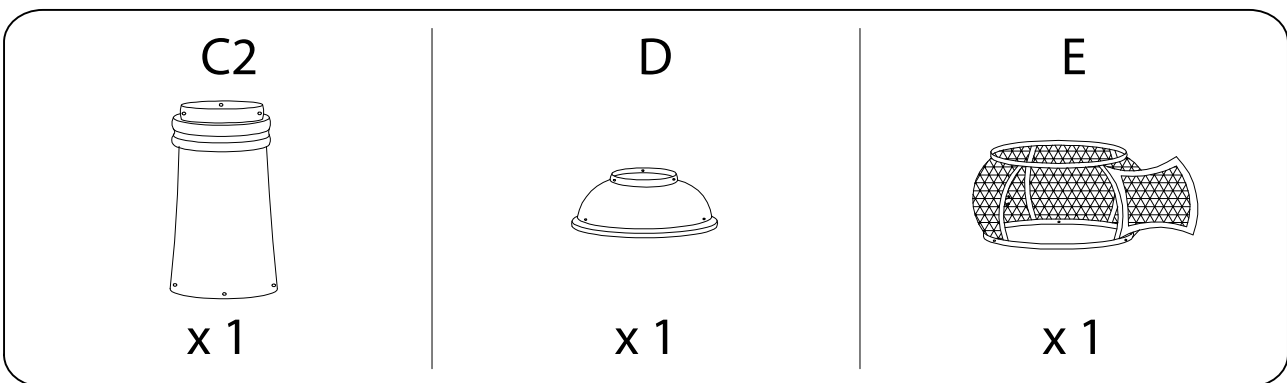

F

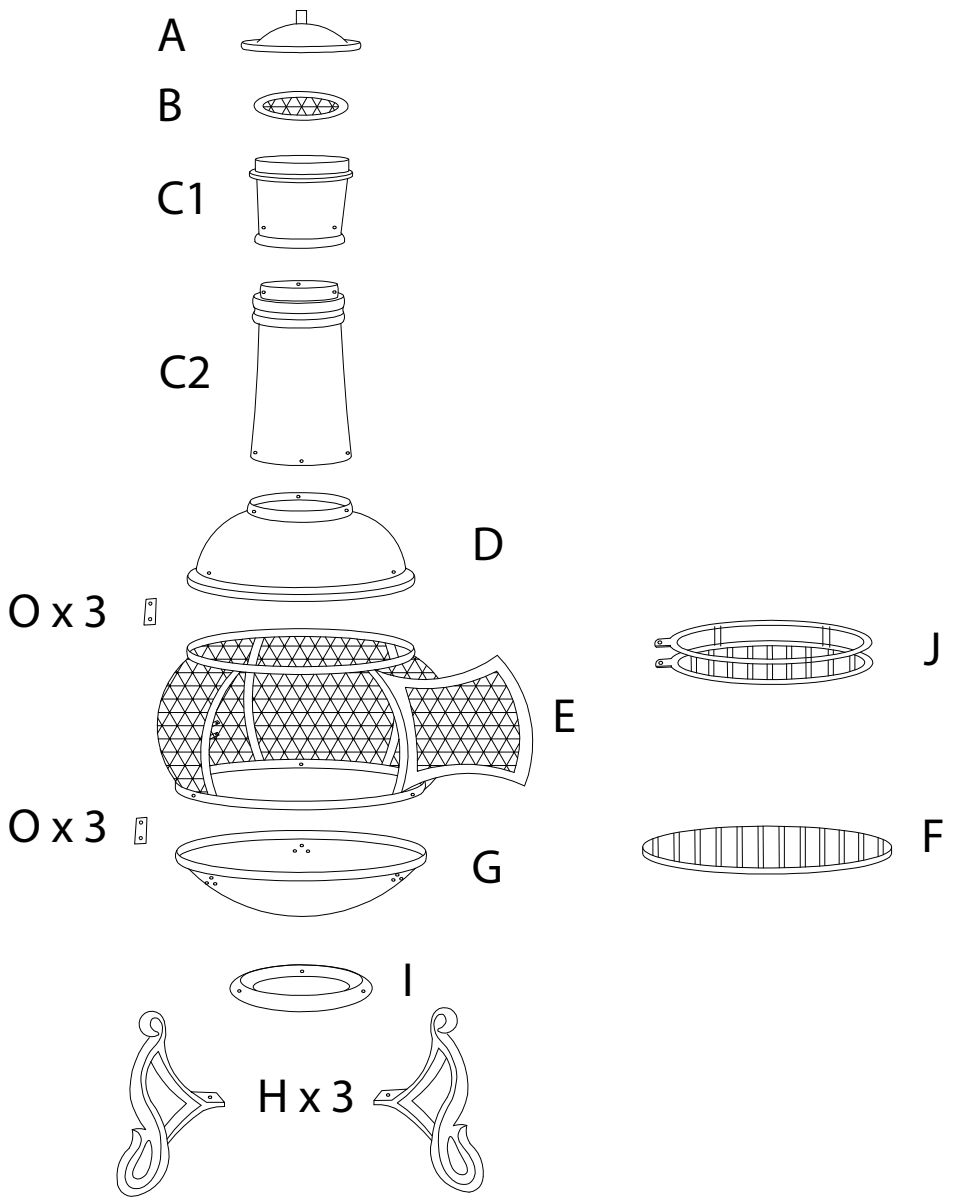
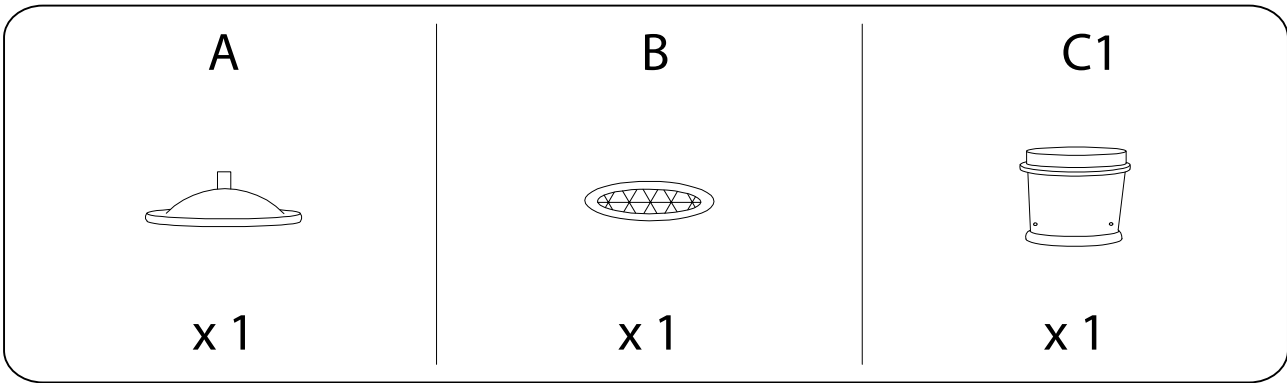
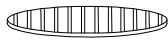

x 1

G



x 1

H

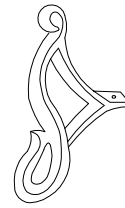

x 3

I

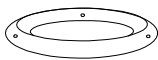

x 1

J



x 1

O

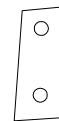

x 6

P

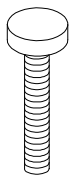

x 1

T1

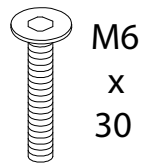

x 3

T2

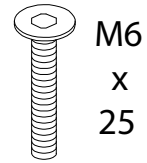

x 9

T3

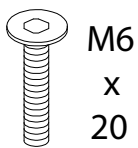

x 15

U

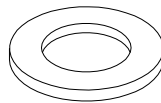

x 27

V

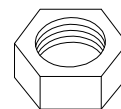

x 27

X

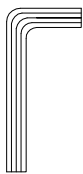

x 1

Y

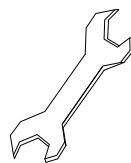



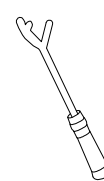

x 1

Z



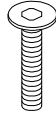

x 1

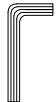
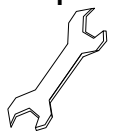
1

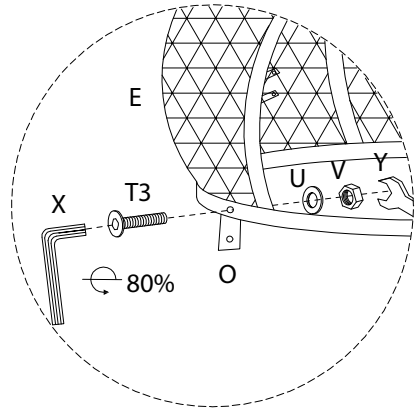
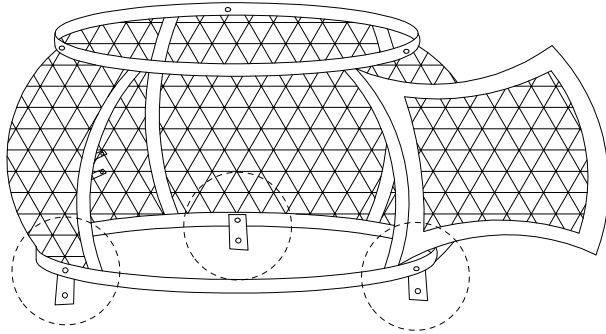
E  x 1	O  x 3	T3 M6 x 20  x 3	U  x 3	V  x 3	X  x 1	Y  x 1
--	--	--	--	---	--	--



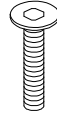
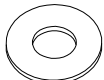

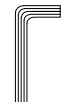
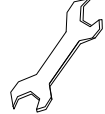

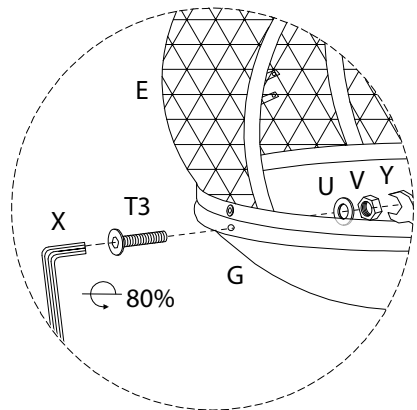
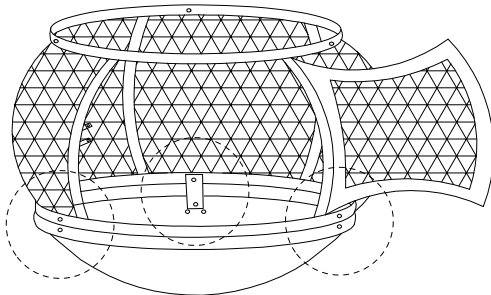
2

G  x 1	T3 M6 x 20  x 3	U  x 3	V  x 3	X  x 1	Y  x 1
--	--	--	---	--	--

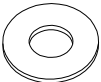



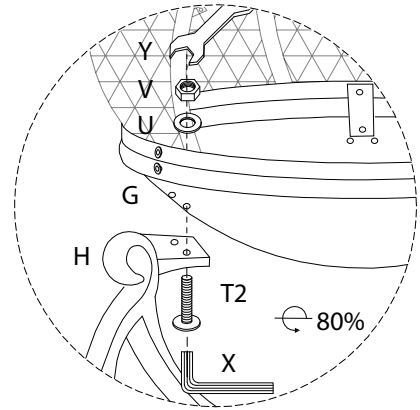
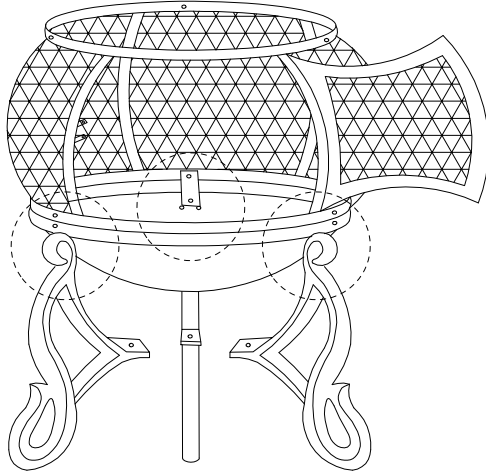

3

H  x 3	T2 M6 x 25 x 6	U  x 6	V  x 6	X  x 1	Y  x 1
--	-----------------------------------	--	---	--	--

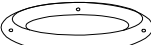
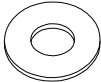

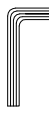

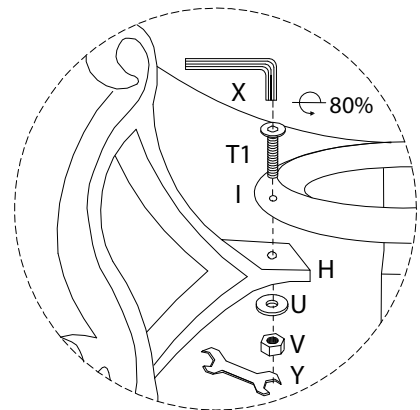
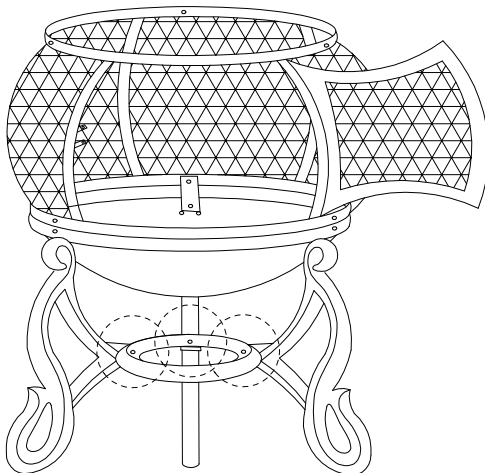

4

I  x 1	T1 M6 x 30 x 3	U  x 3	V  x 3	X  x 1	Y  x 1
--	-----------------------------------	--	---	--	--



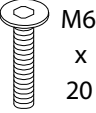

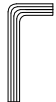
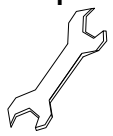
5

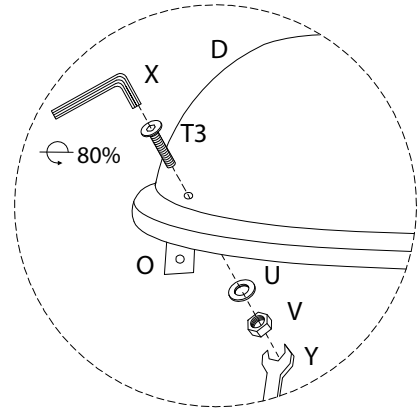
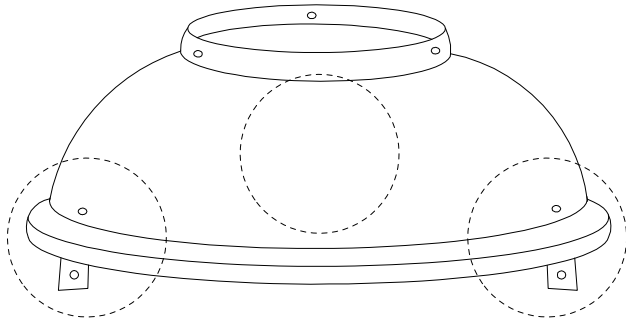
D  x 1	O  x 3	T3  M6 x 20 x 3	U  x 3	V  x 3	X  x 1	Y  x 1
--	--	---	--	---	--	--



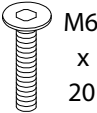

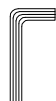
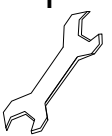

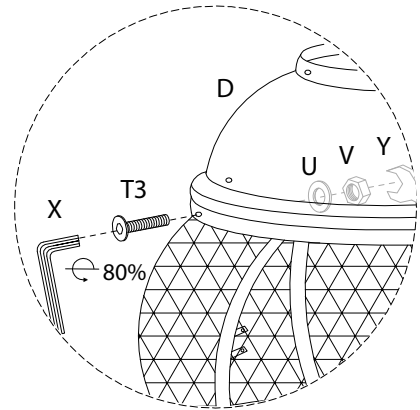
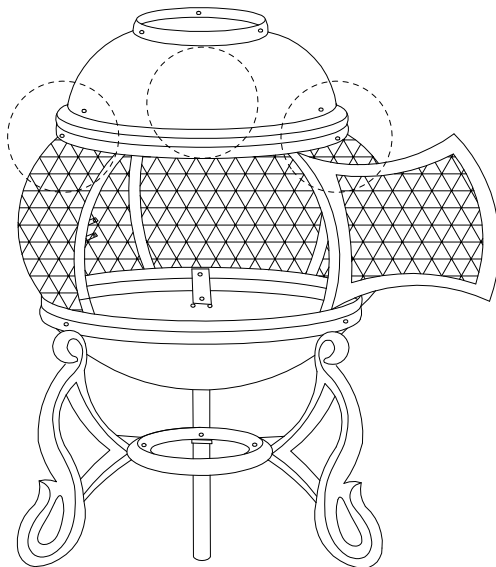
6

T3  M6 x 20 x 3	U  x 3	V  x 3	X  x 1	Y  x 1
---	--	--	--	--



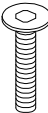

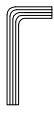
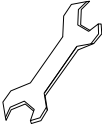
7

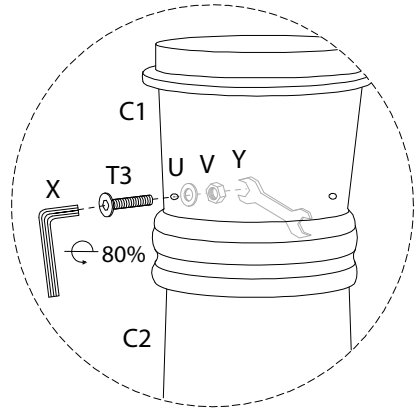
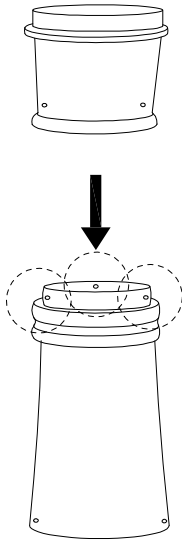
C1	C2	T3 M6 x 20	U	V	X	Y
						
x 1	x 1	x 3	x 3	x 3	x 1	x 1

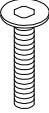

8

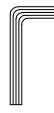
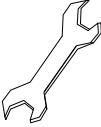
T2 M6 x 25	U	V	X	Y
				
x 3	x 3	x 3	x 1	x 1

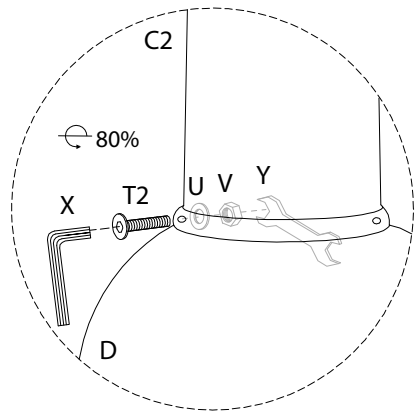
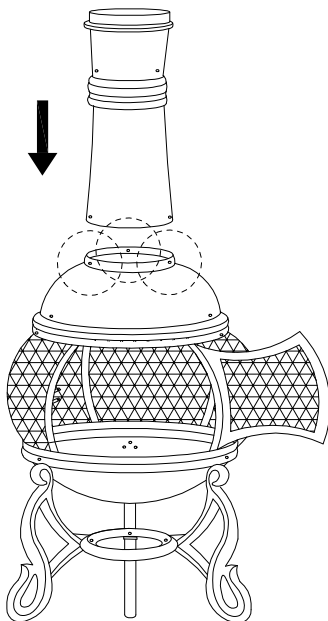

9

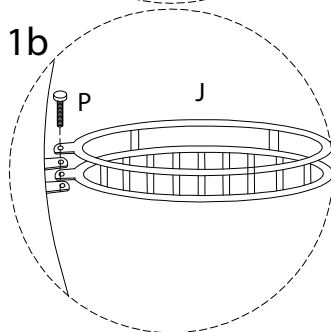
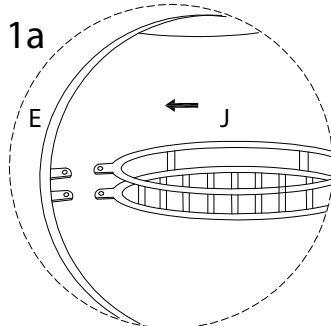
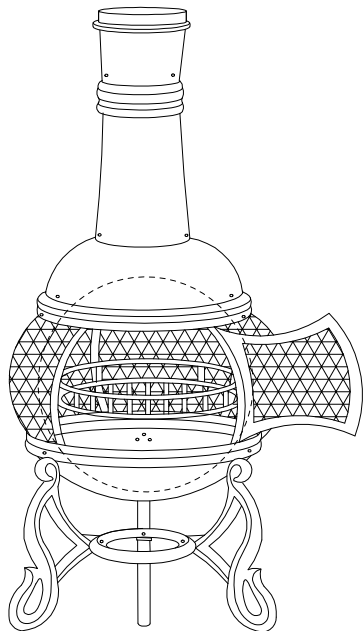
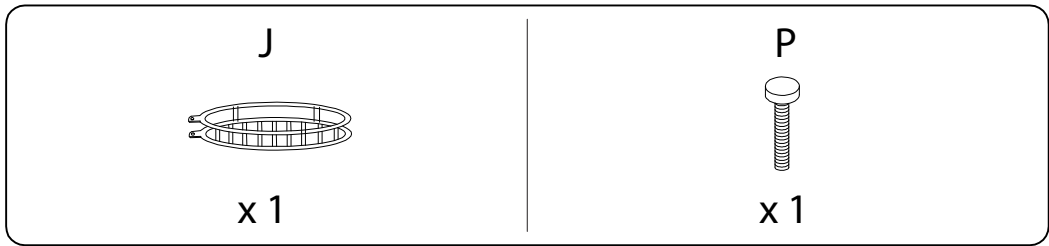

10

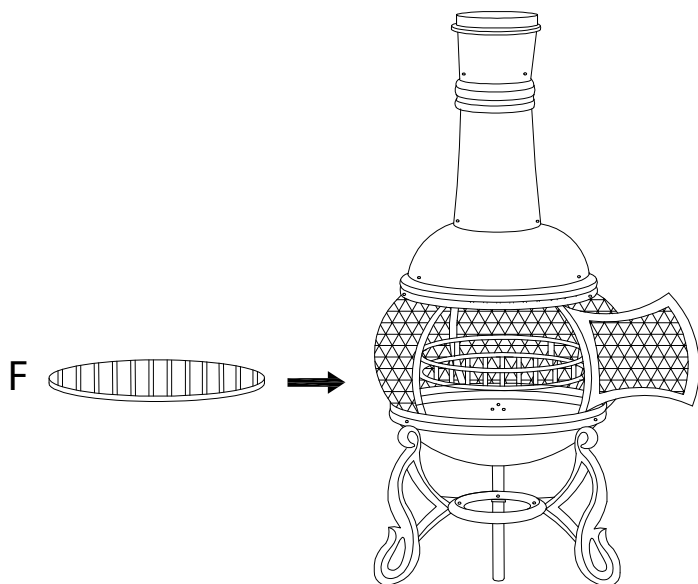
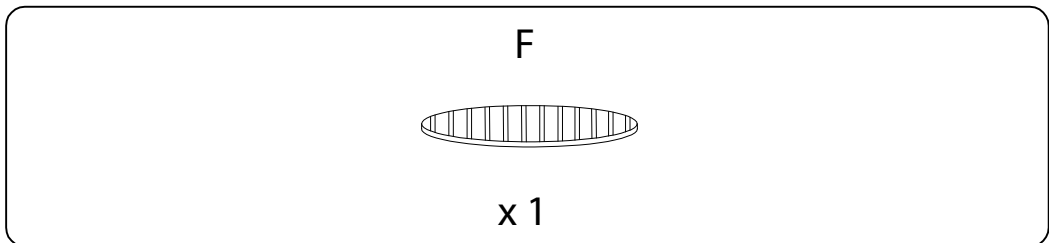

11

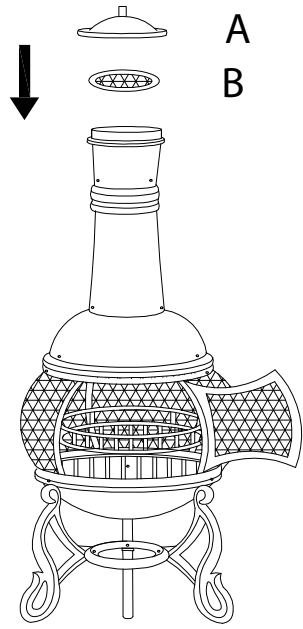
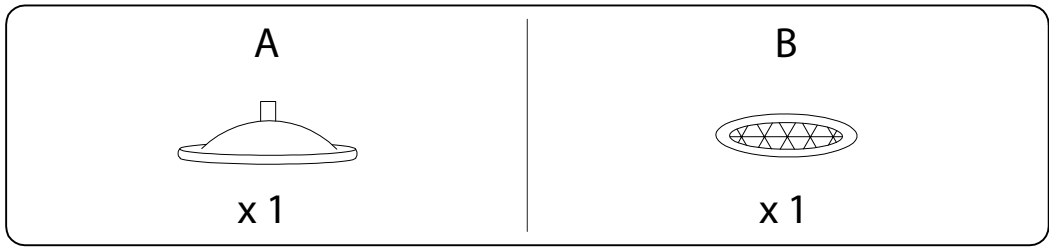

!

