

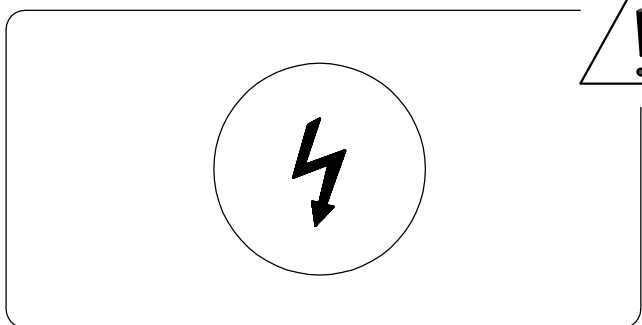

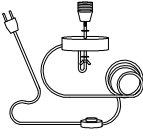

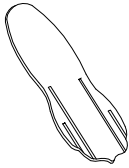

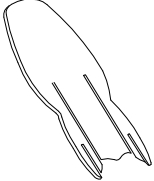

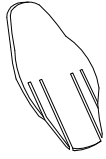

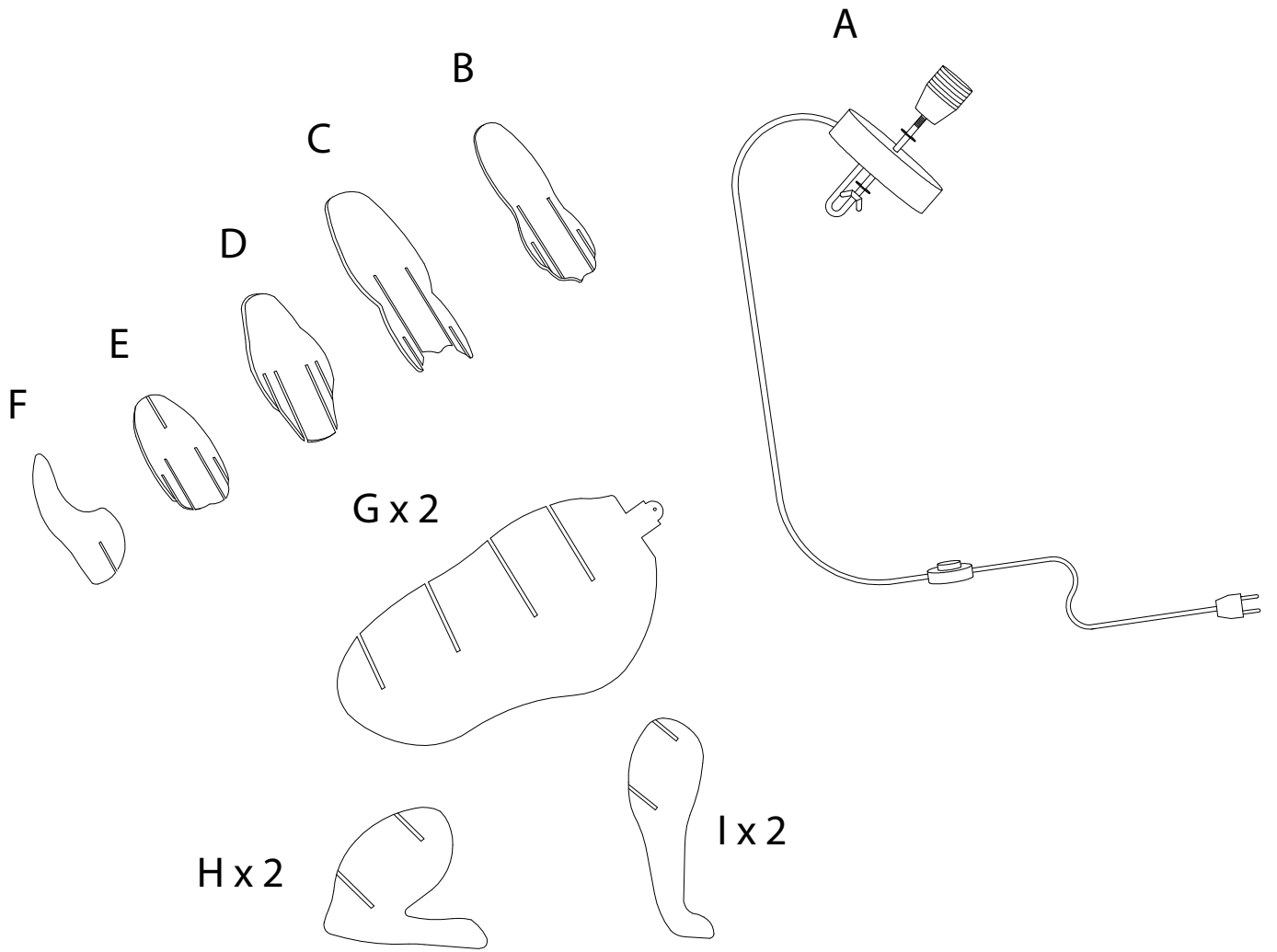
20'

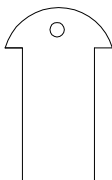

1

A	B	C	D	E	F
					
x 1	x 1	x 1	x 1	x 1	x 1

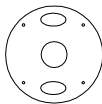

G	H	I	J	K	L	M
						
x 2	x 2	x 2	x 2	x 1	x 1	x 2

1

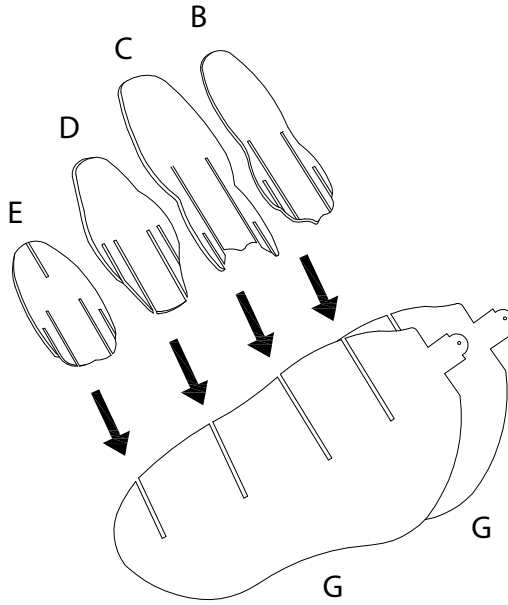
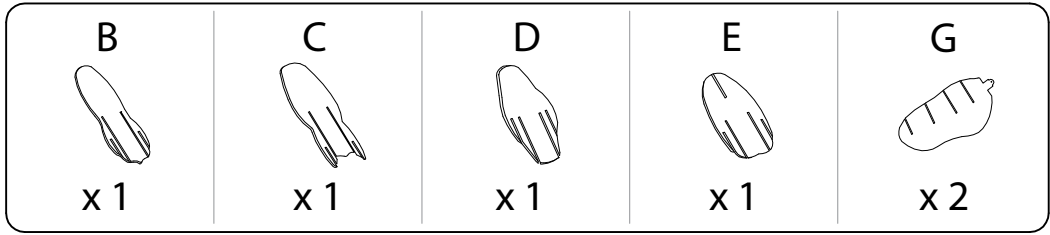

2

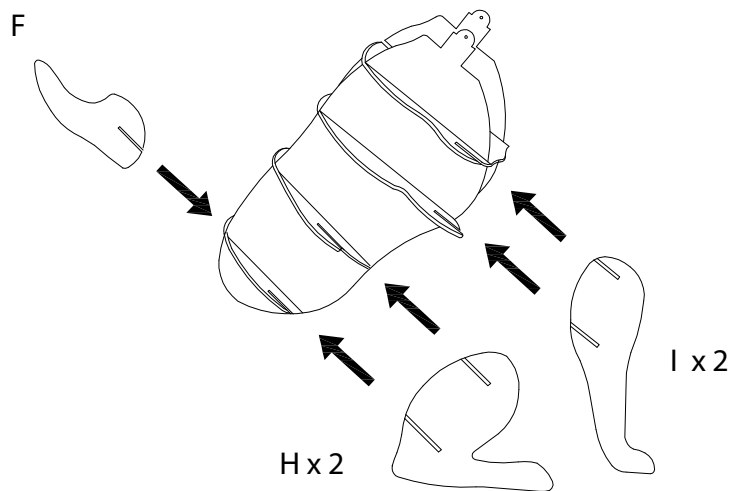
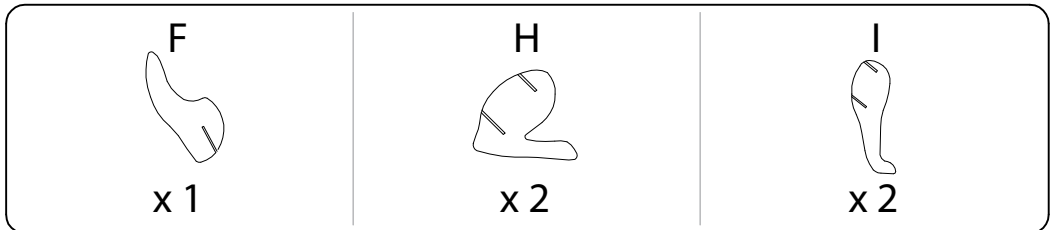

3

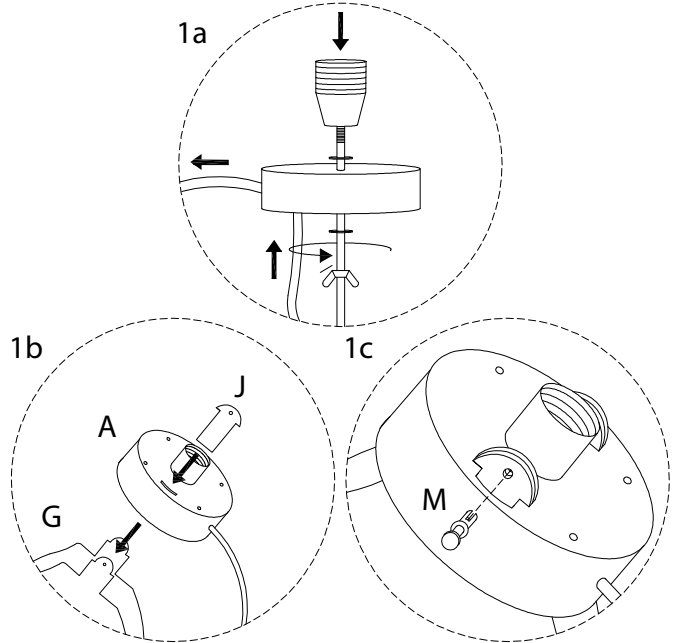
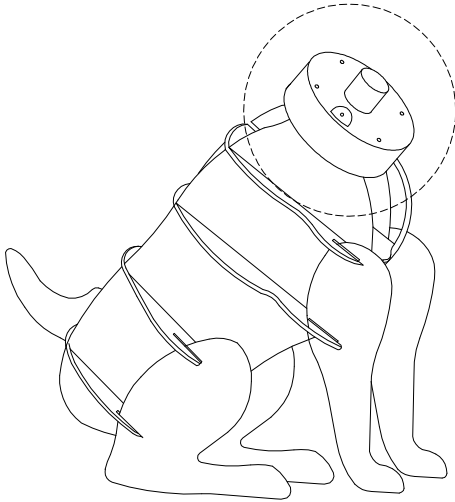
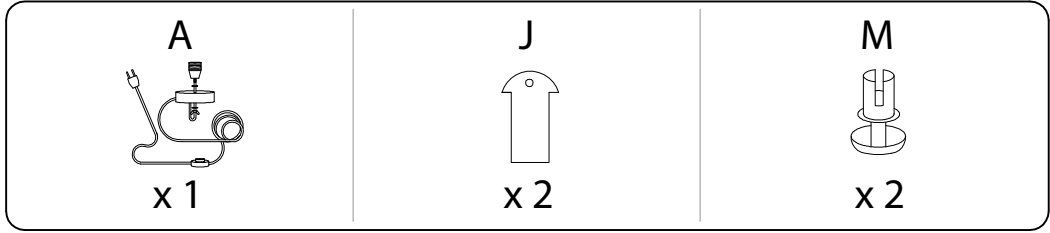

4

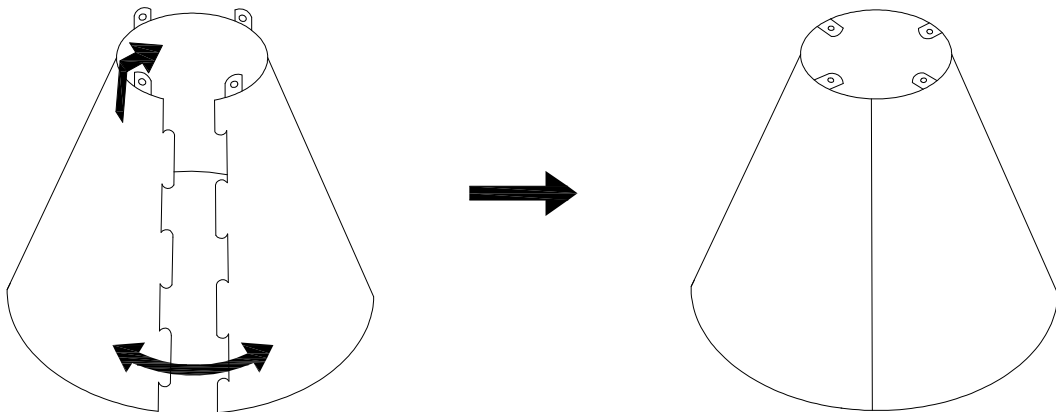
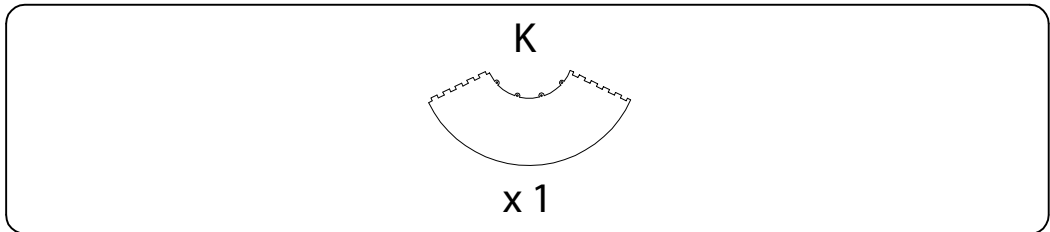

5

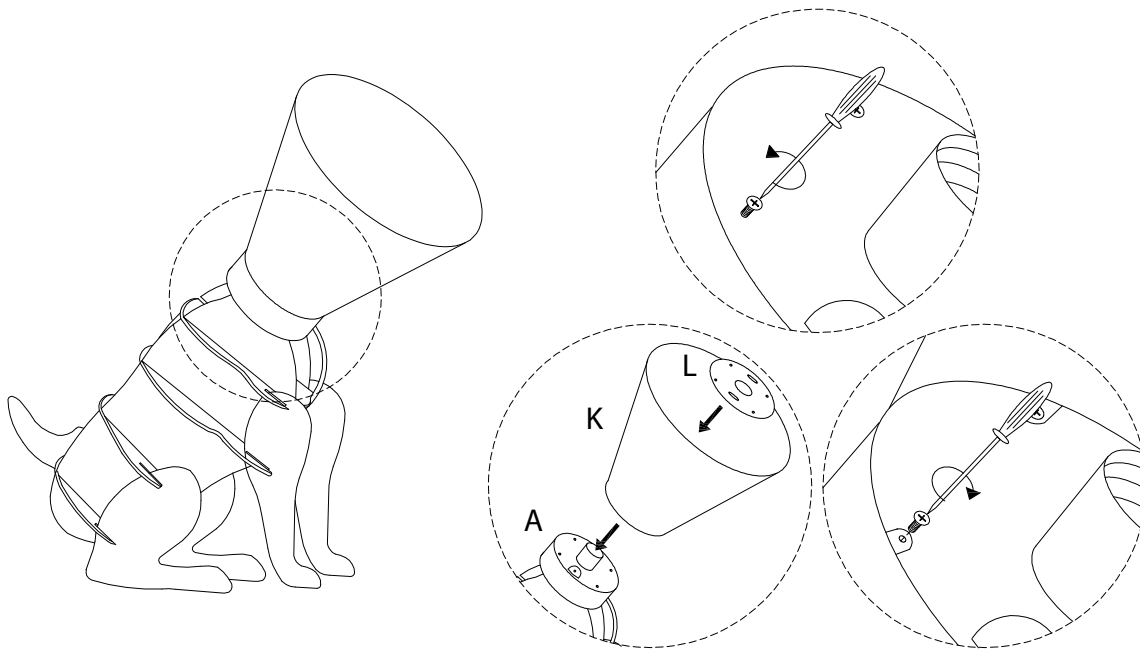
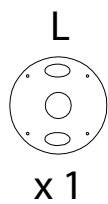

6

