

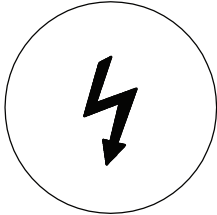

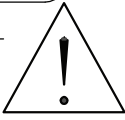

		5'
		
		1

A	B	C	D	E
				
x 1	x 6	x 6	x 1	x 2

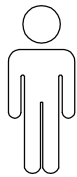
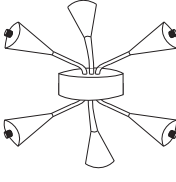
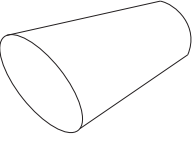
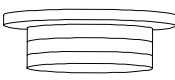

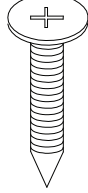
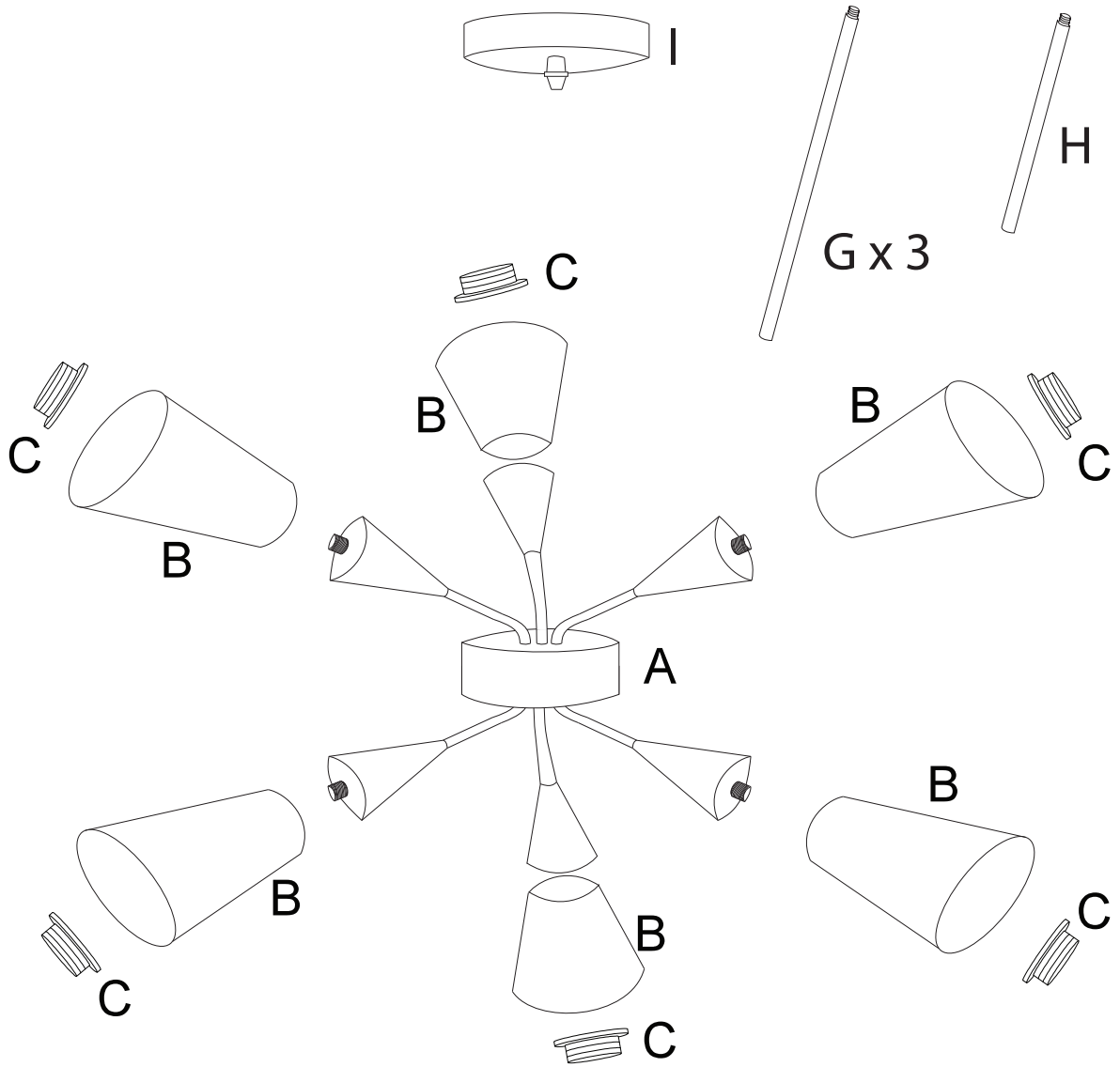
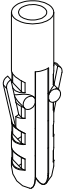
F	G	H	I
			
x 2	x 3	x 1	x 1

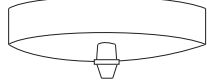
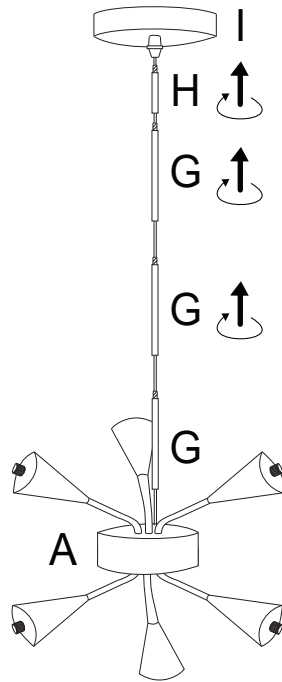
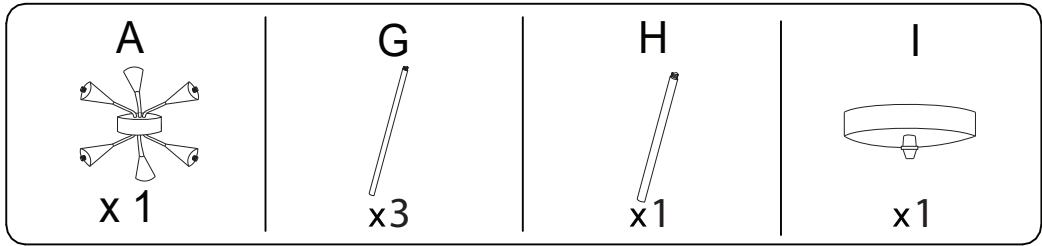
1



2

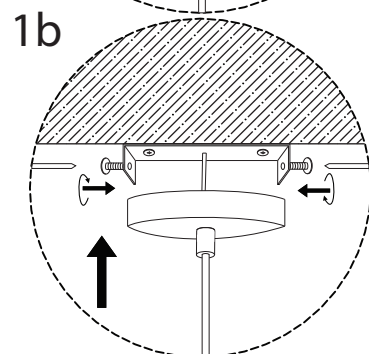
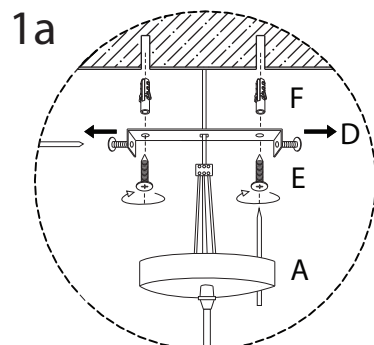
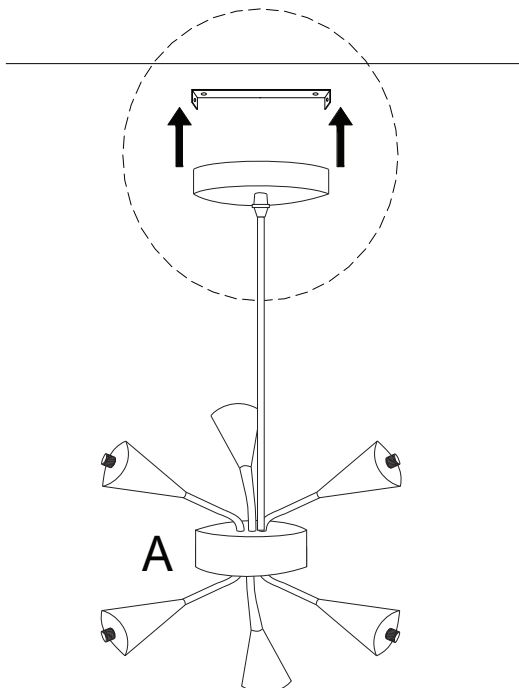
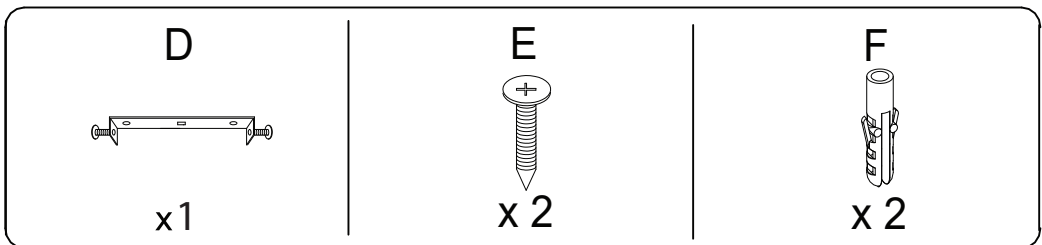

3

B

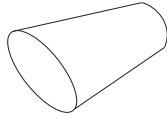

x 6

C

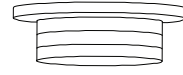

x 6

