

ERGES

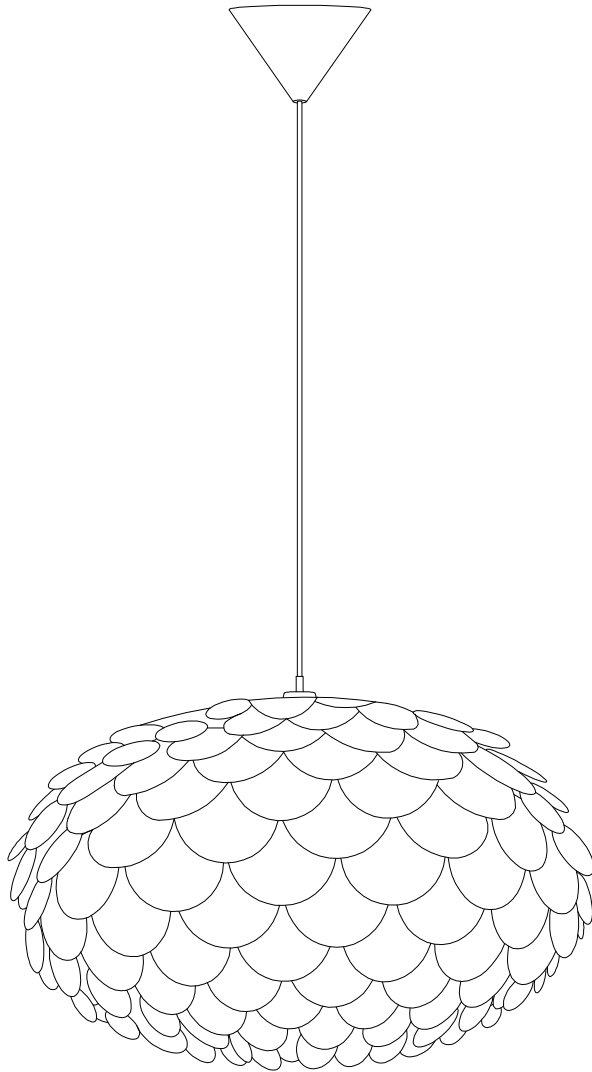

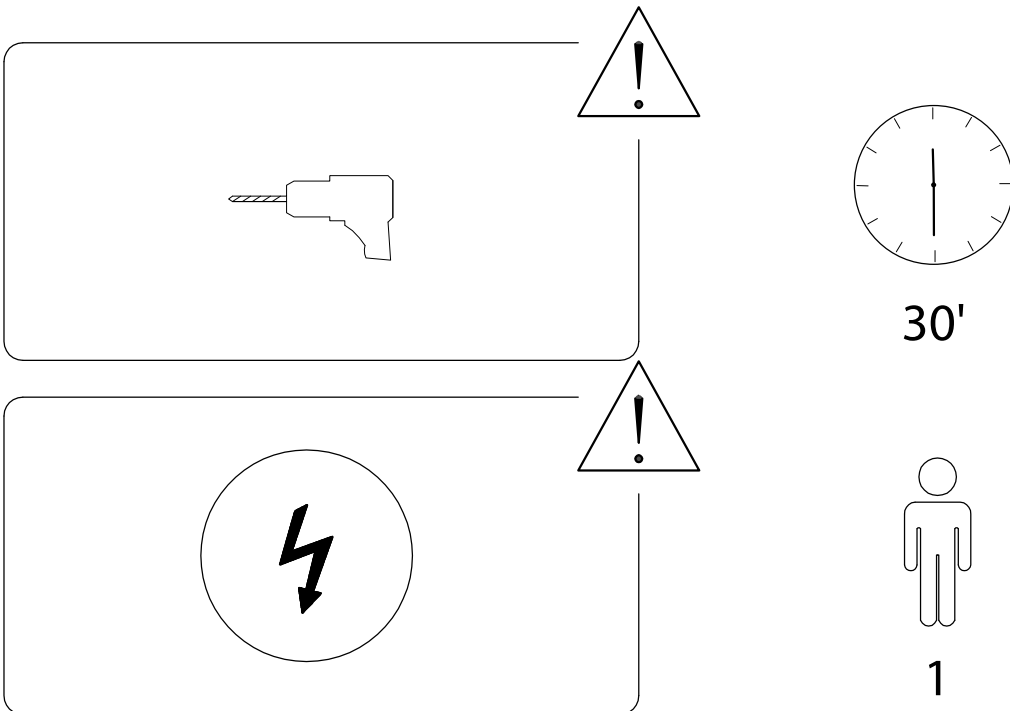

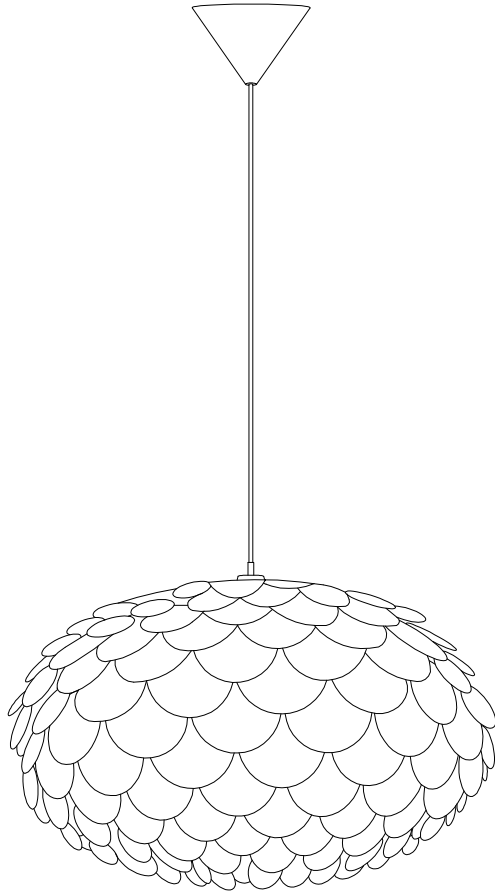

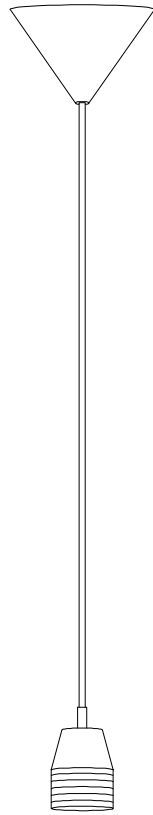

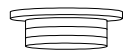

A

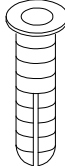

B

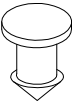
A	B	C	D	E
				
x 1	x 1	x 1	x 1	x 72

1

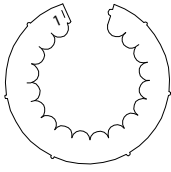

x 1

2

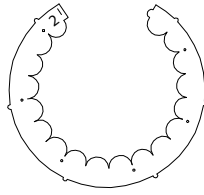

x 1

3

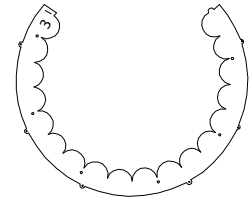

x 1

4

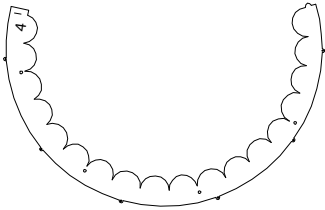

x 1

5

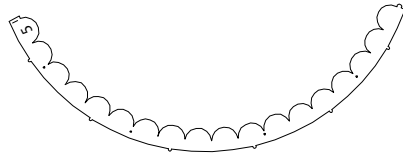

x 1

6

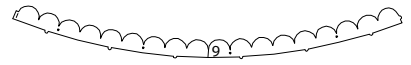

x 1

7



x 1

8

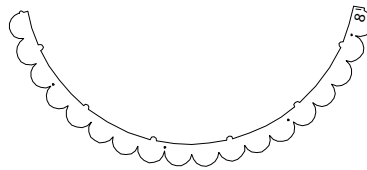

x 1

9

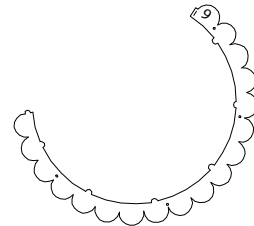

x 1

10

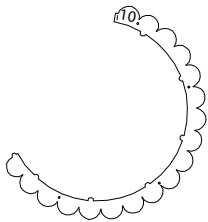

x 1

11

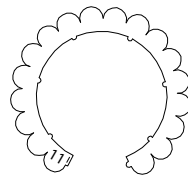

x 1

12

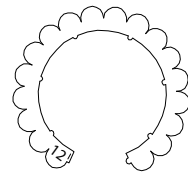





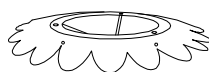





x 1

13

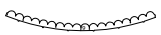

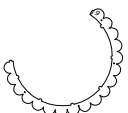
x 1

3

1  x1	2  x1	3  x1	4  x1	5  x1	6  x1
7  x1	8  x1	9  x1	10  x1	11  x1	12  x1

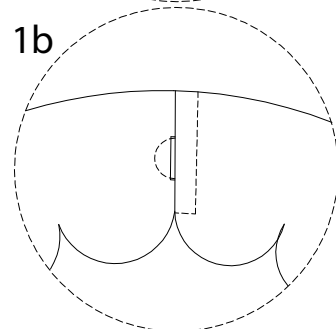
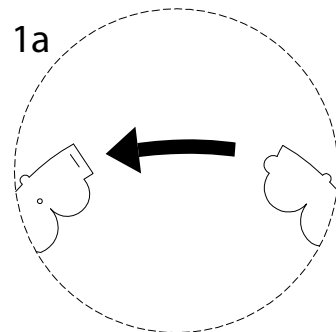
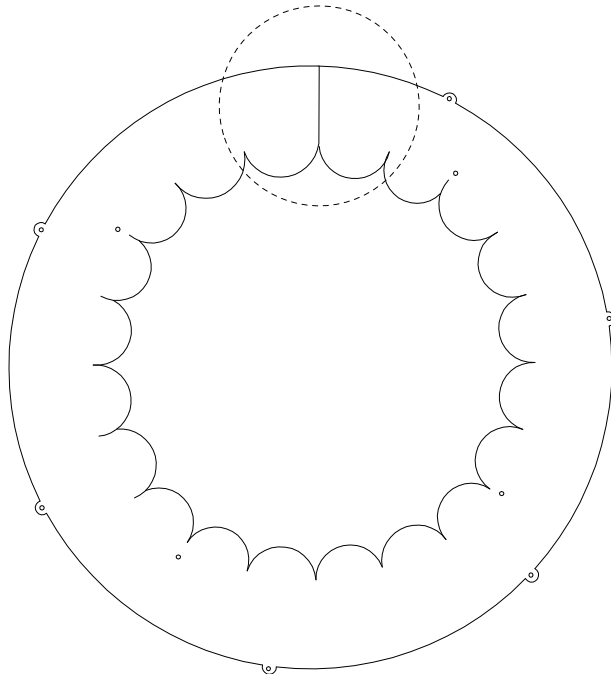

2

E



x 72

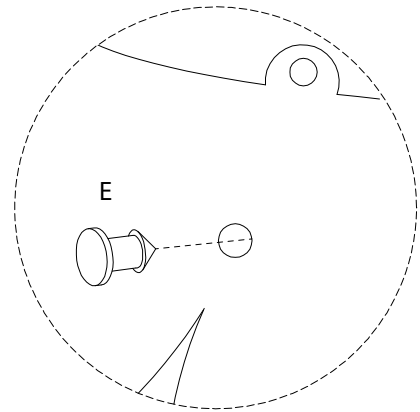
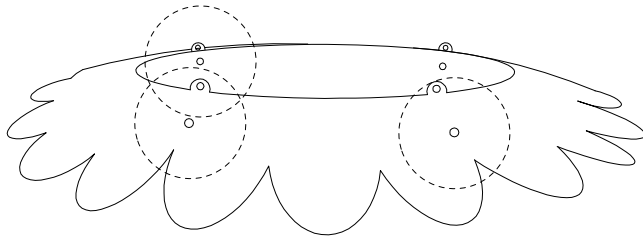

3

13



x 1

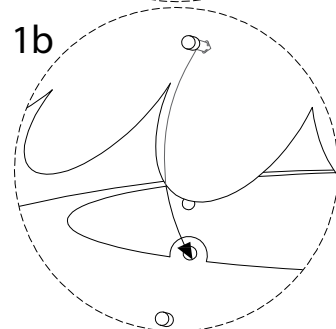
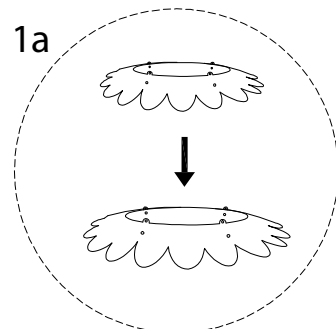
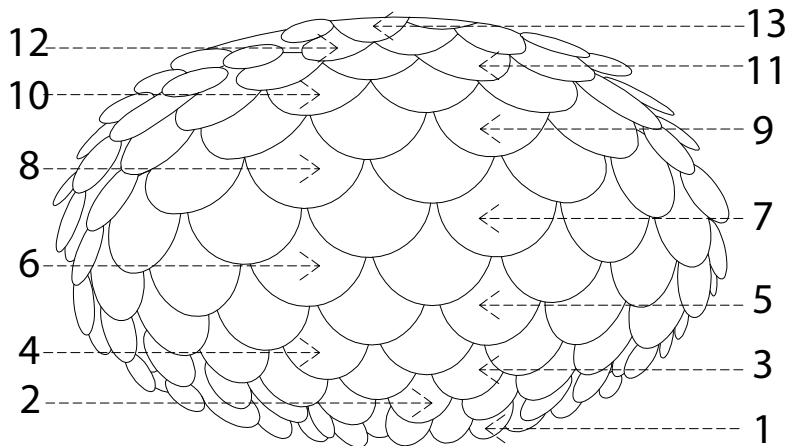

4

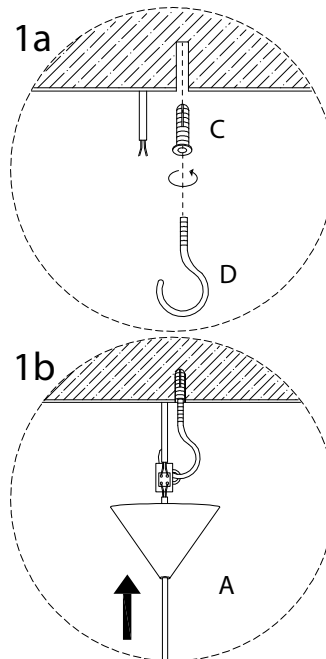
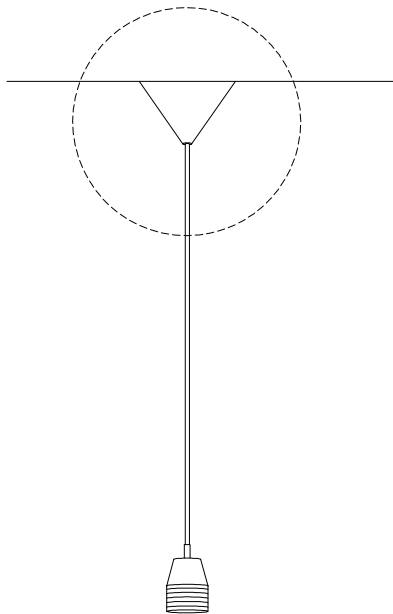
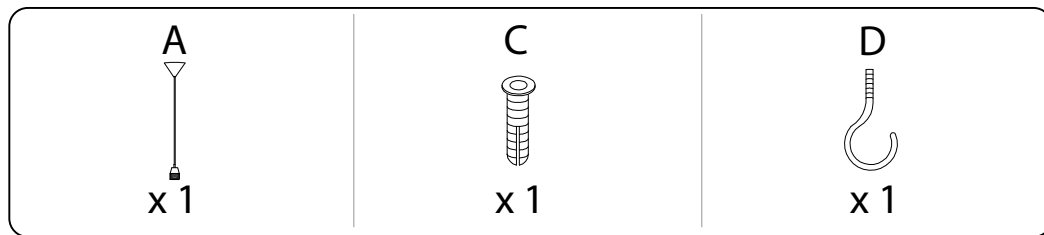

5

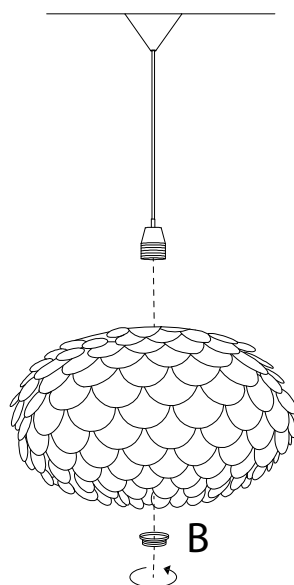
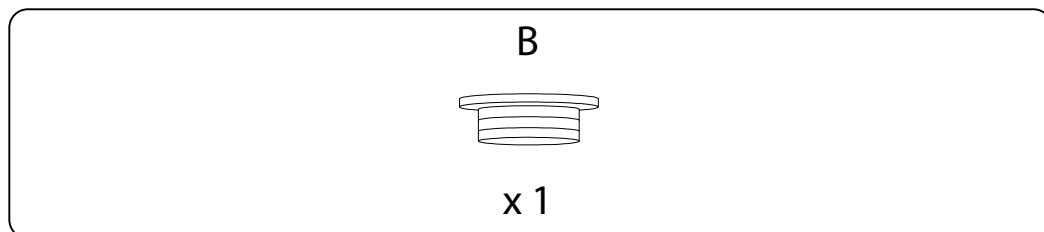

6

