

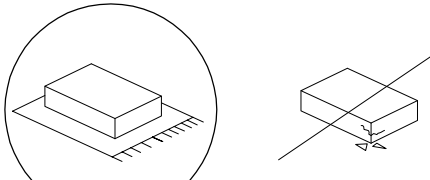

		<b>15'</b>
		
		<b>1</b>

<b>A</b>	<b>B</b>	<b>C</b>	<b>D</b>
			
<b>x 1</b>	<b>x 2</b>	<b>x 2</b>	<b>x 1</b>



**C x 2**

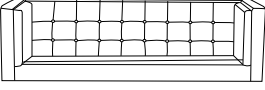
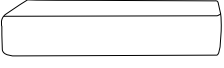
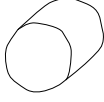
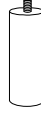

**B x 2**

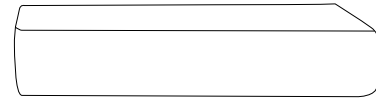
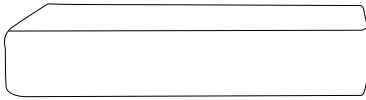

**A**

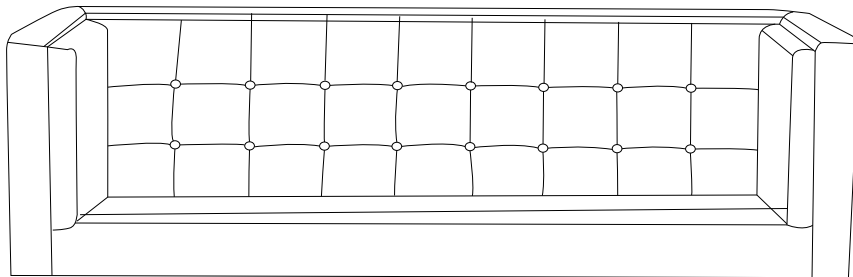

**D**

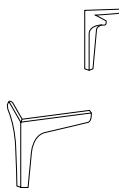

**E x 4**

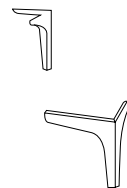

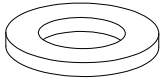
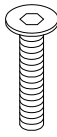
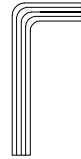
<b>E</b>	<b>F</b>	<b>G</b>	<b>H</b>
		 M6 x 24	
<b>x 4</b>	<b>x 8</b>	<b>x 8</b>	<b>x 1</b>

1

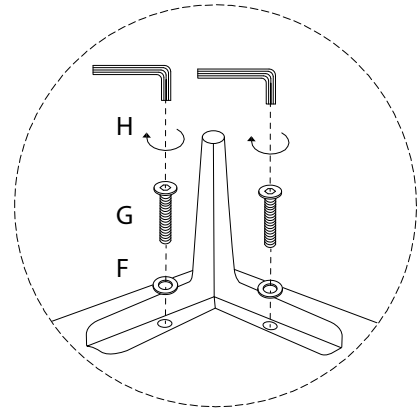
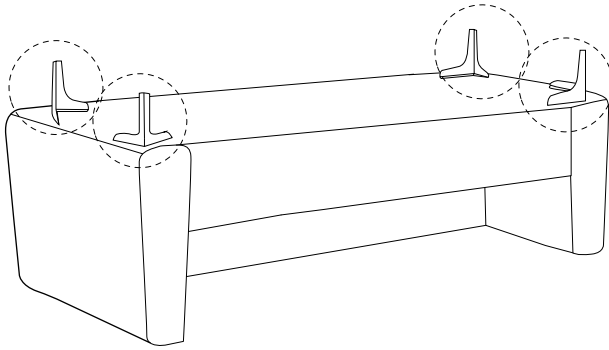
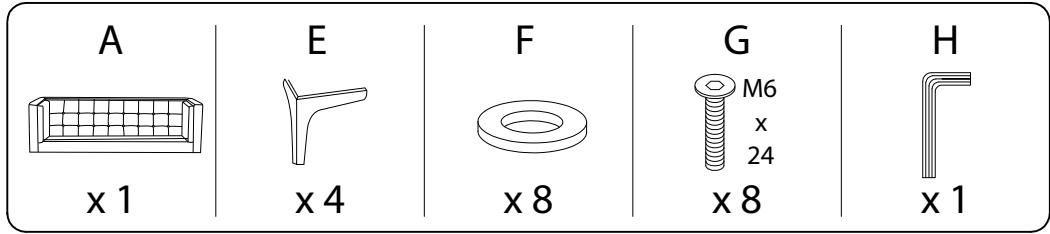

2

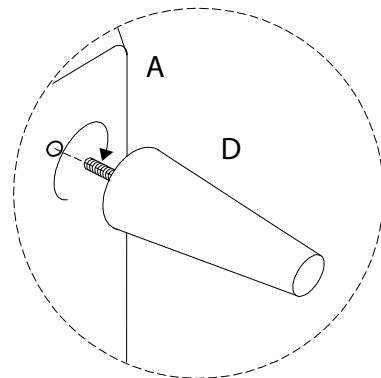
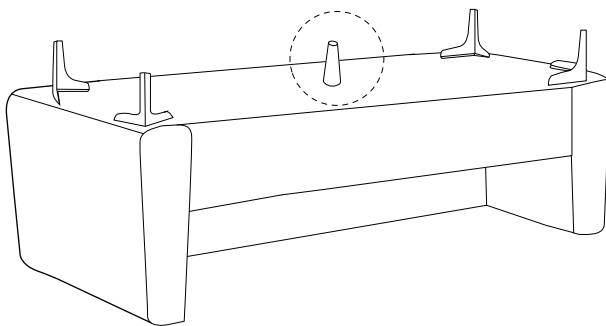

3

