

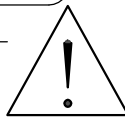

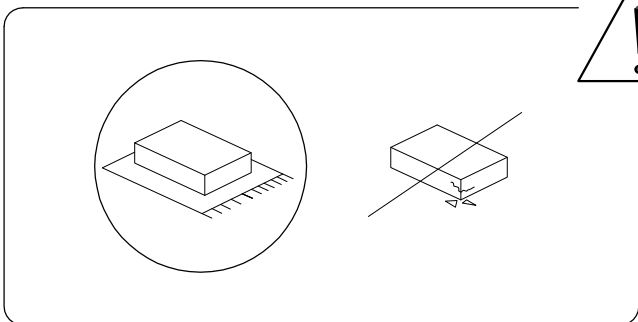

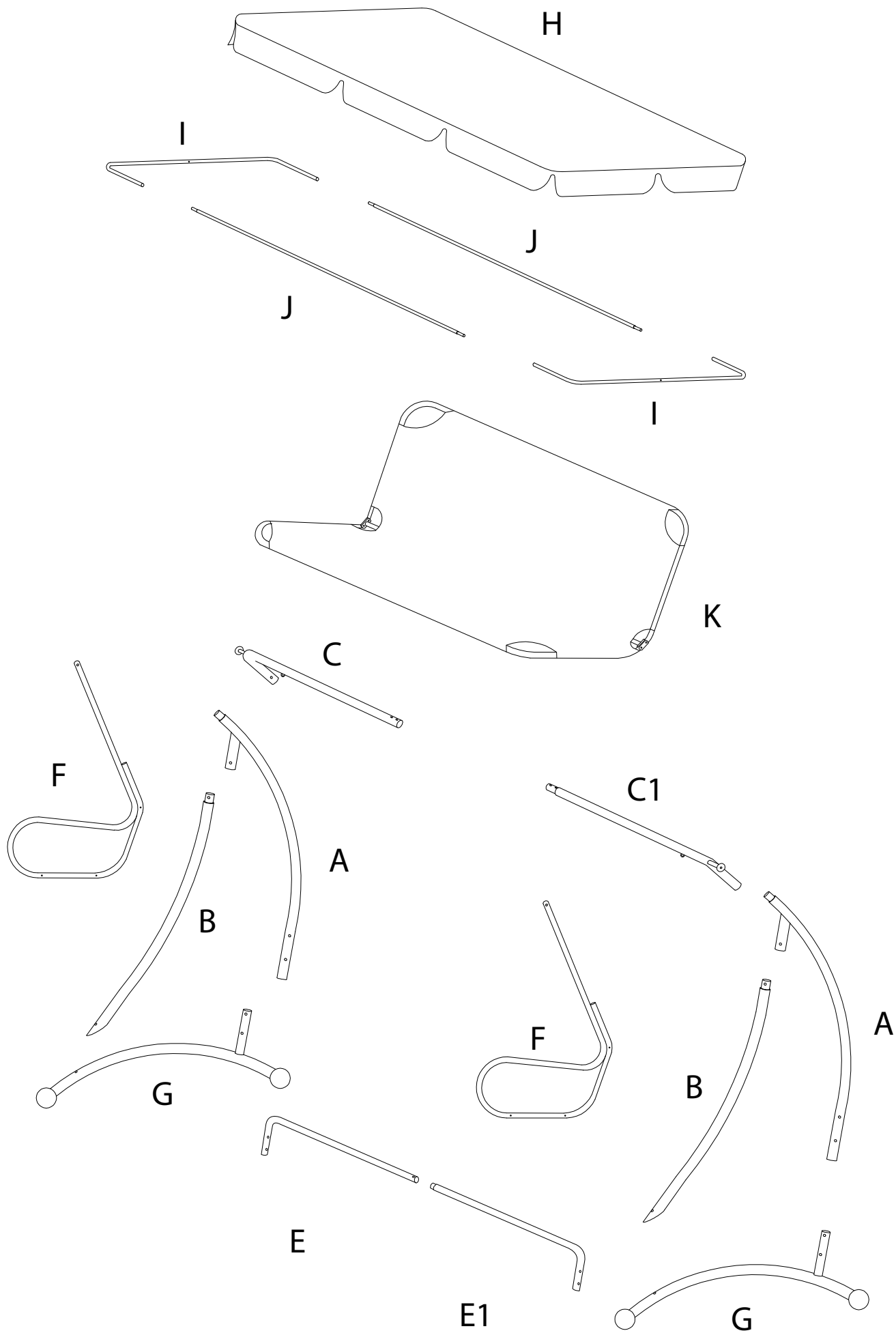

90'

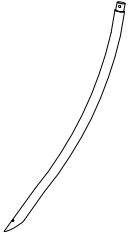
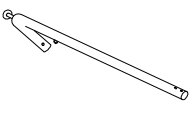
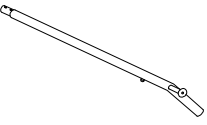
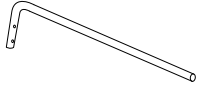
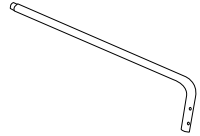
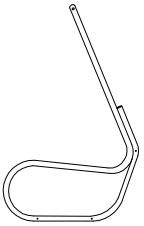

2

1/10

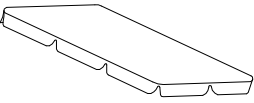

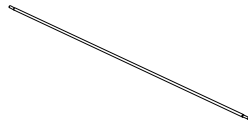
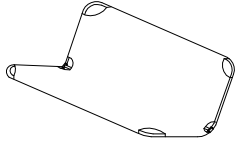
<p>A</p>  <p>x 2</p>	<p>B</p>  <p>x 2</p>	<p>C</p>  <p>x 1</p>	<p>C1</p>  <p>x 1</p>
<p>E</p>  <p>x 1</p>	<p>E1</p>  <p>x 1</p>	<p>F</p>  <p>x 2</p>	<p>G</p>  <p>x 2</p>
<p>H</p>  <p>x 1</p>	<p>I</p>  <p>x 2</p>	<p>J</p>  <p>x 2</p>	<p>K</p>  <p>x 1</p>

L

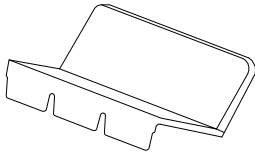

x 1

M

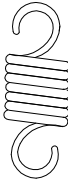

x 2

N

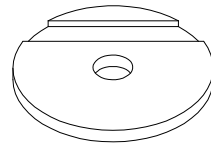

x 4

O

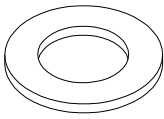

x 7

P

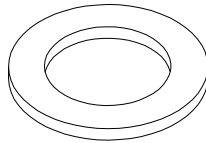

x 12

Q

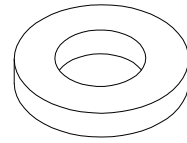

x 6

R

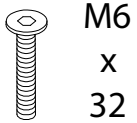

M6
x
32

x 1

S

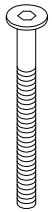

M6
x
70

x 6

T

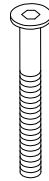

M8
x
58

x 8

U

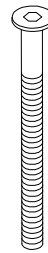

M8
x
80

x 6

V

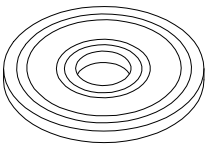

x 2

W

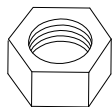

x 7

X

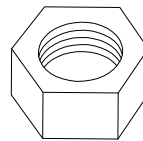

x 12

Y

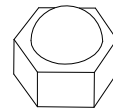

x 11

Z

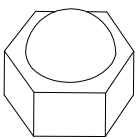

x 12

Γ



x 1

Δ

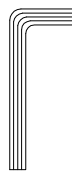



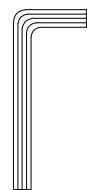

x 1

Θ





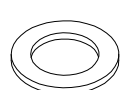
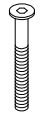
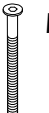
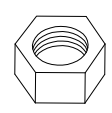
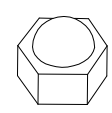

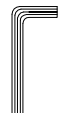

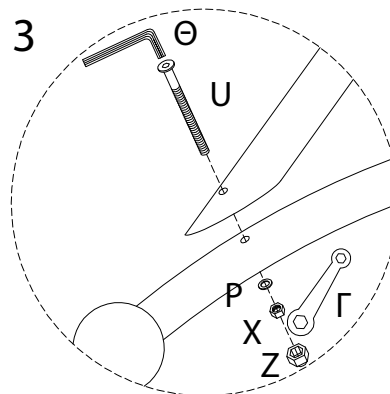
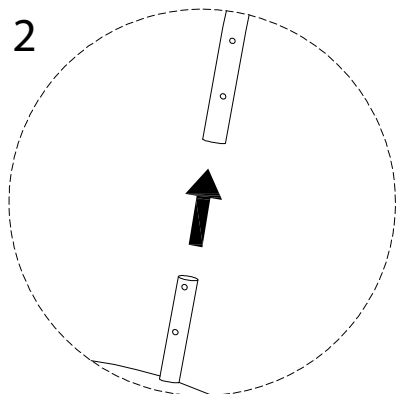
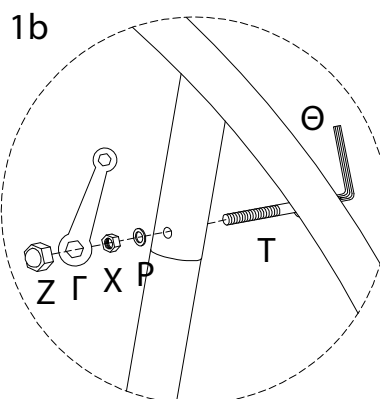
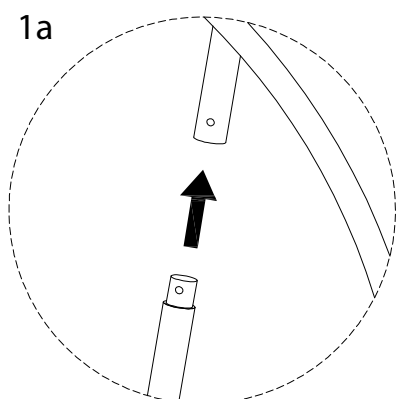
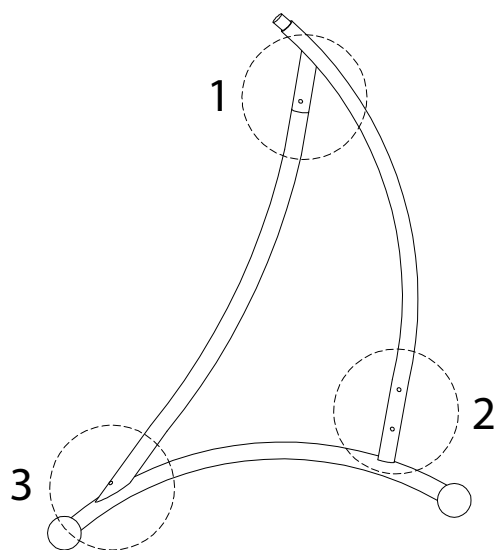
x 1

1 x 2

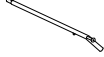
A  x 1	B  x 1	G  x 1	P  x 2	T  M8 x 58 x 1
U  M8 x 80 x 1	X  x 2	Z  x 2	Γ  x 1	Θ  x 1

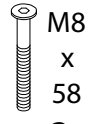

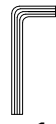

2

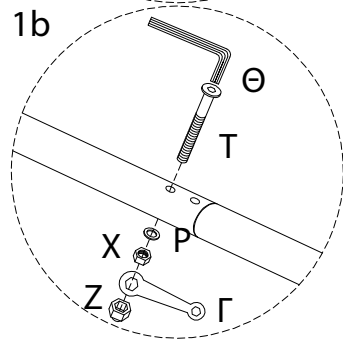
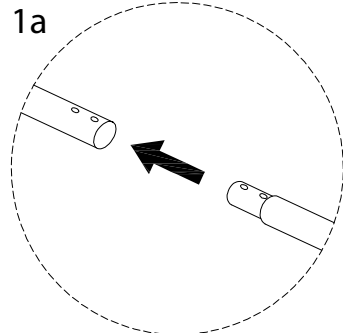
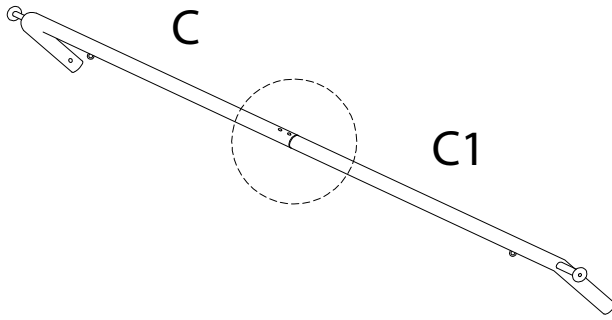
C	C1	P	T M8 x 58	X	Z	Г	Θ
							
x1	x1	x2	x2	x2	x2	x1	x1



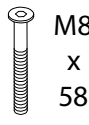
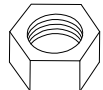
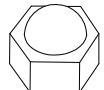

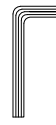

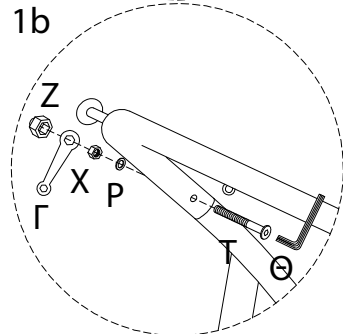
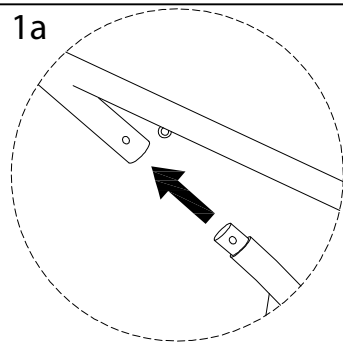
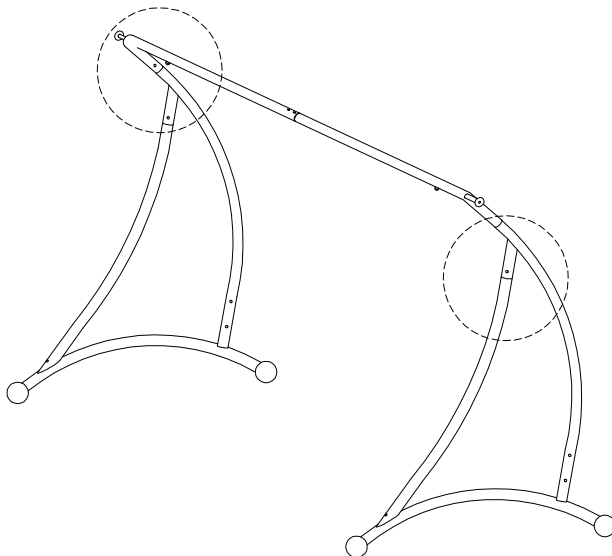

3

P	T M8 x 58	X	Z	Г	Θ
					
x2	x2	x2	x2	x1	x1

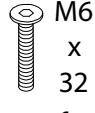

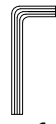

4

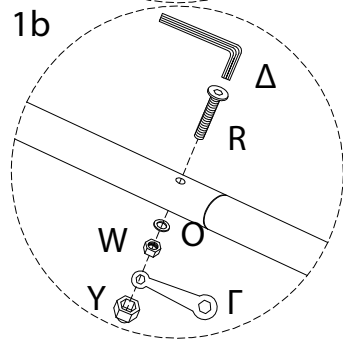
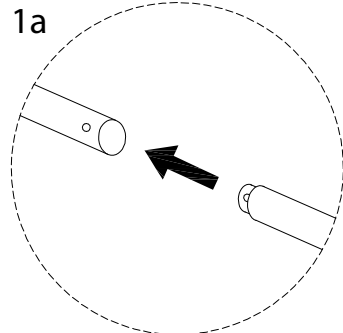
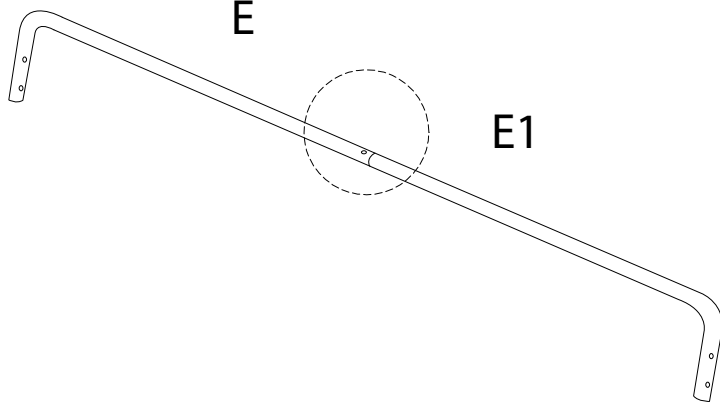
E	E1	O	R	W	Y	Г	Δ
							
x1	x1	x1	x1	x1	x1	x1	x1



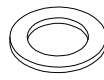
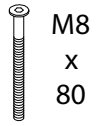
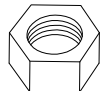
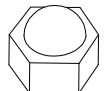

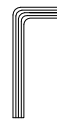

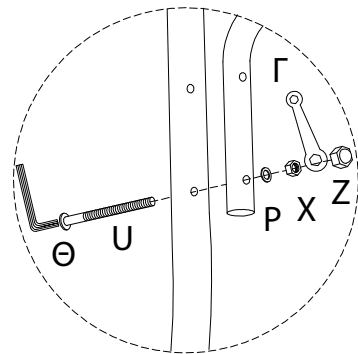
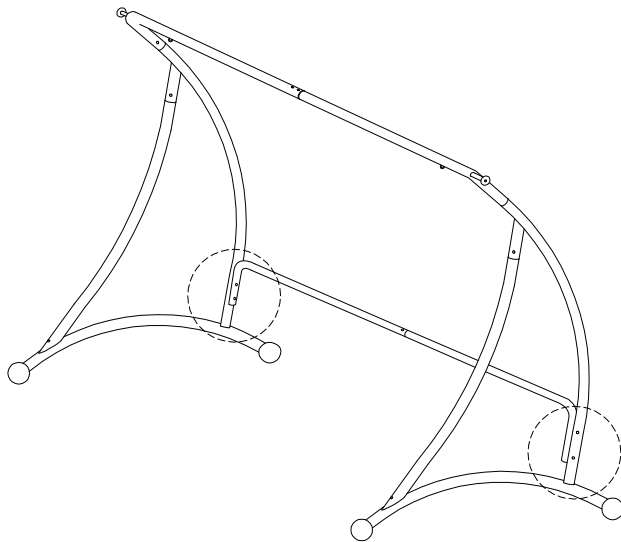
5

P	U	X	Z	Г	Θ
					
x4	x4	x4	x4	x1	x1

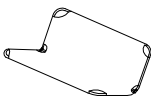
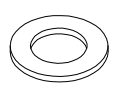
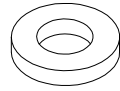
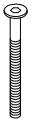

6

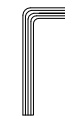
<p>F</p>  <p>x 2</p>	<p>K</p>  <p>x 1</p>	<p>O</p>  <p>x 6</p>	<p>Q</p>  <p>x 6</p>	
<p>S</p>  <p>M6 x 70 x 6</p>	<p>W</p>  <p>x 6</p>	<p>Y</p>  <p>x 10</p>	<p>Г</p>  <p>x 1</p>	<p>Δ</p>  <p>x 1</p>

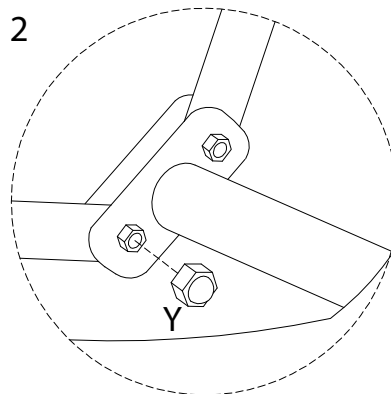
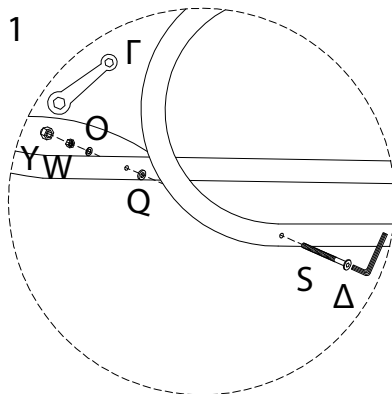
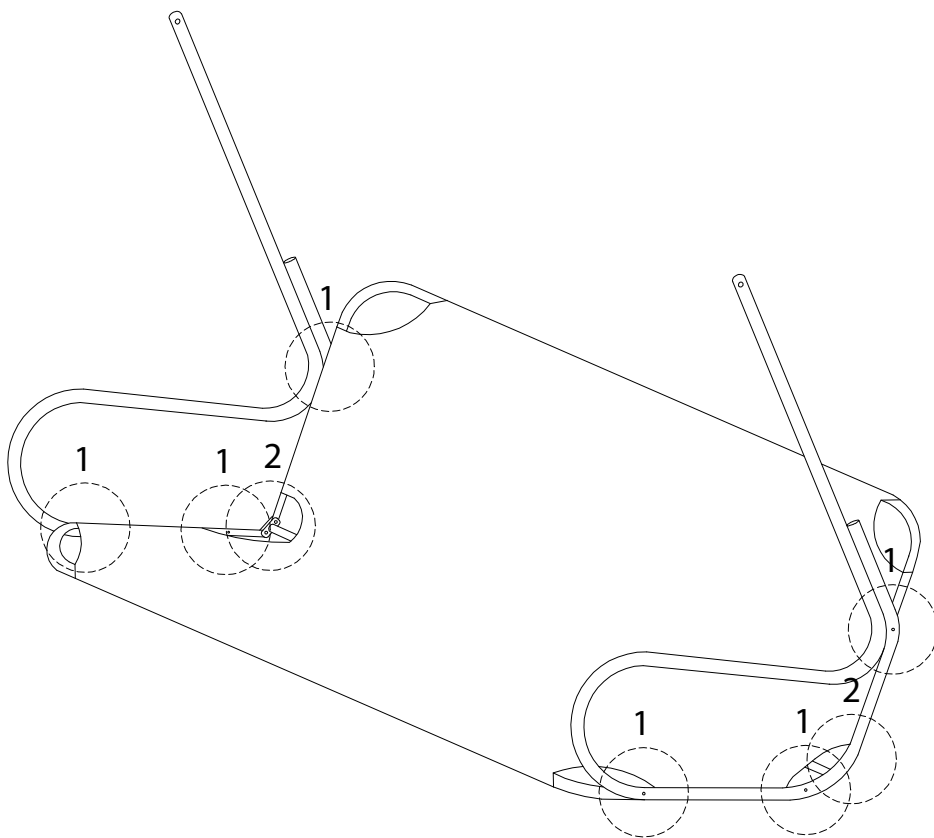

7

M

x 2

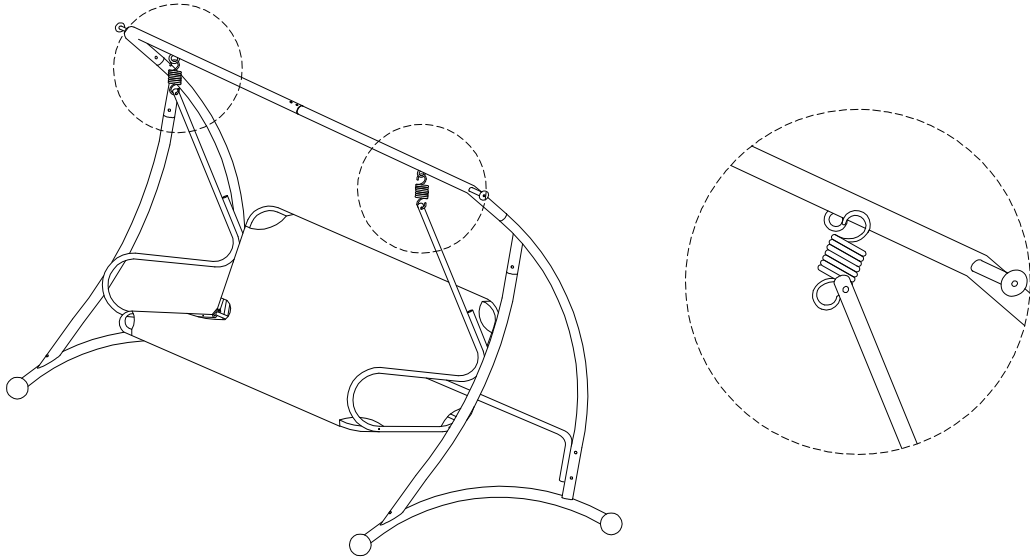

8

I

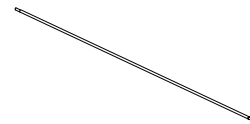
x 2

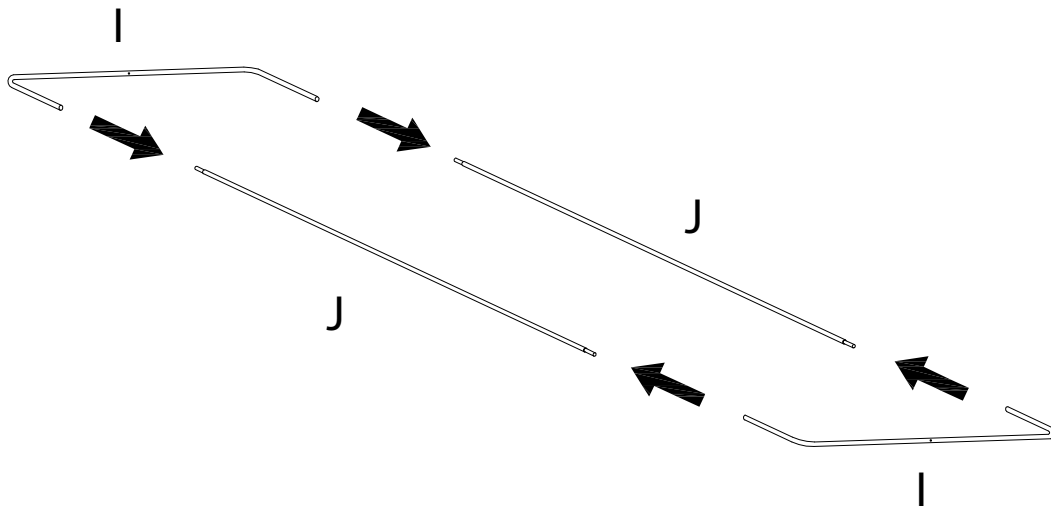
J

x 2

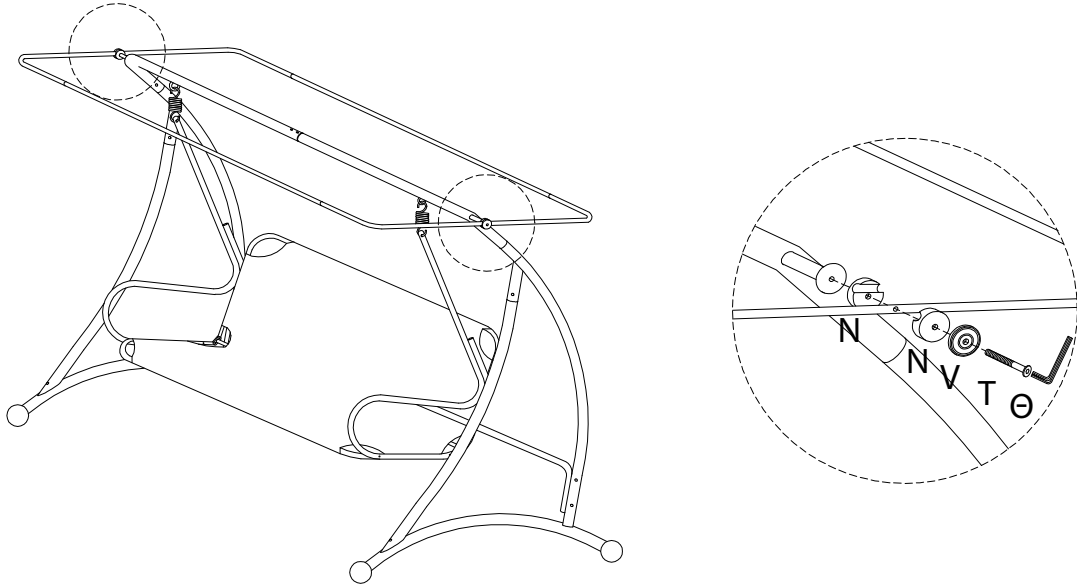
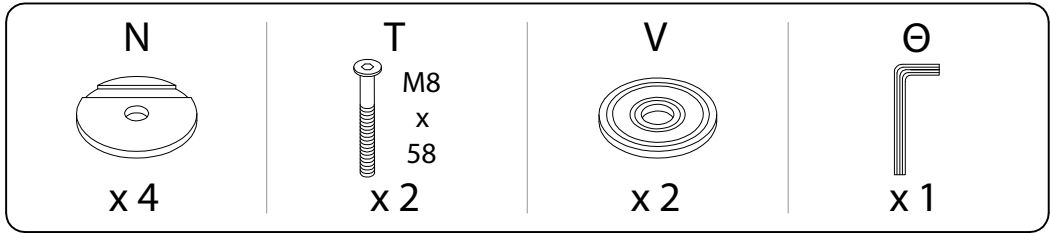

9



10

