

CLIPPER / SALSA

S55-REG1D2S

A	B	C	D
1	S55-111	2020	367
2	S55-112	2020	367
3	S55-303	456	367
4	S55-304	454	366
5	S55-403	456	60
6	S55-402	456	59
7	S55-501	350	120
8	S55-502	350	120
9	S55-503	407	120
10	S55-904	418	348
11	S55-903	1955	483

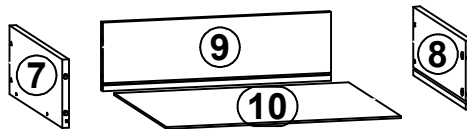
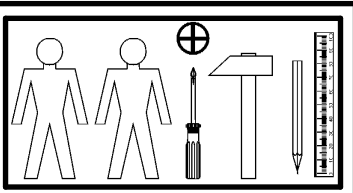
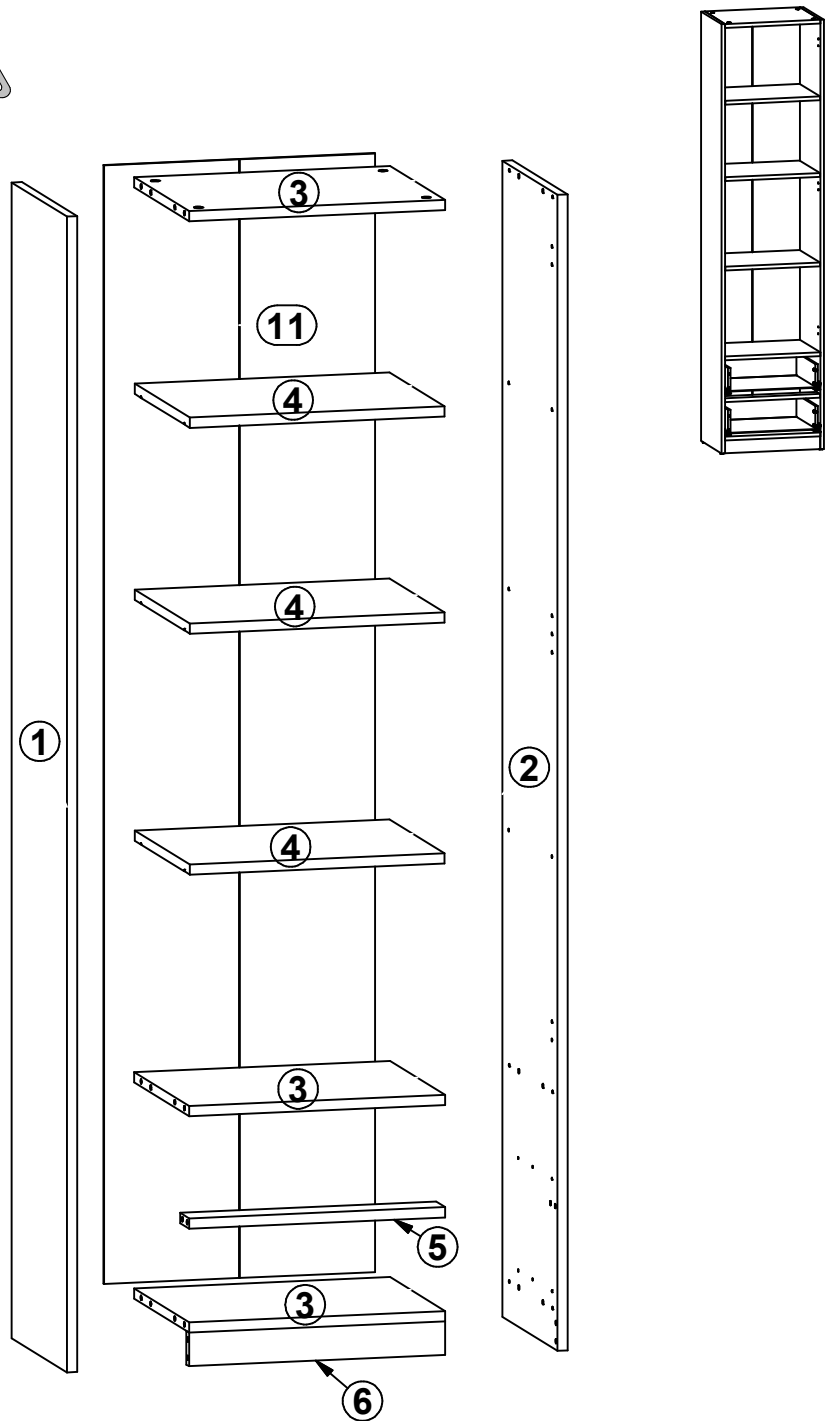

12x φ5x17 mm d1	12x φ6x13 mm e3	8x φ5x9 mm e19	20x φ8x30 mm f1	8x φ6.5x40 mm f25	4x k1	60x l1	12x φ1.5x12mm #16 r1	8x φ12x10.5mm #12 r15
20x r16	12x φ5 s4	2x 350 mm w45\CL	2x 350 mm w45\CR	2x 350 mm w45\DL	2x 350 mm w45\DR	1x n26\1	1x φ3.5x16 mm p38	

1 

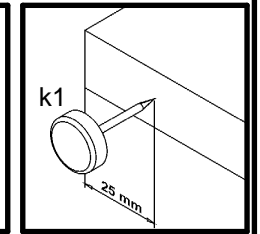
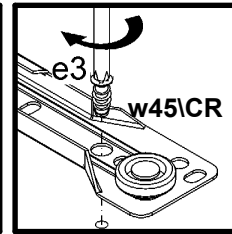
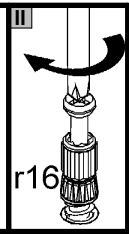
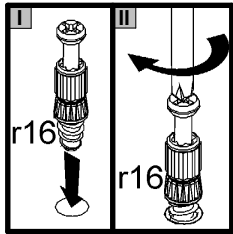
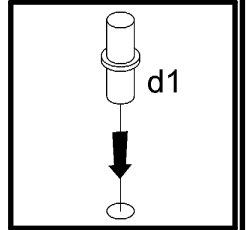
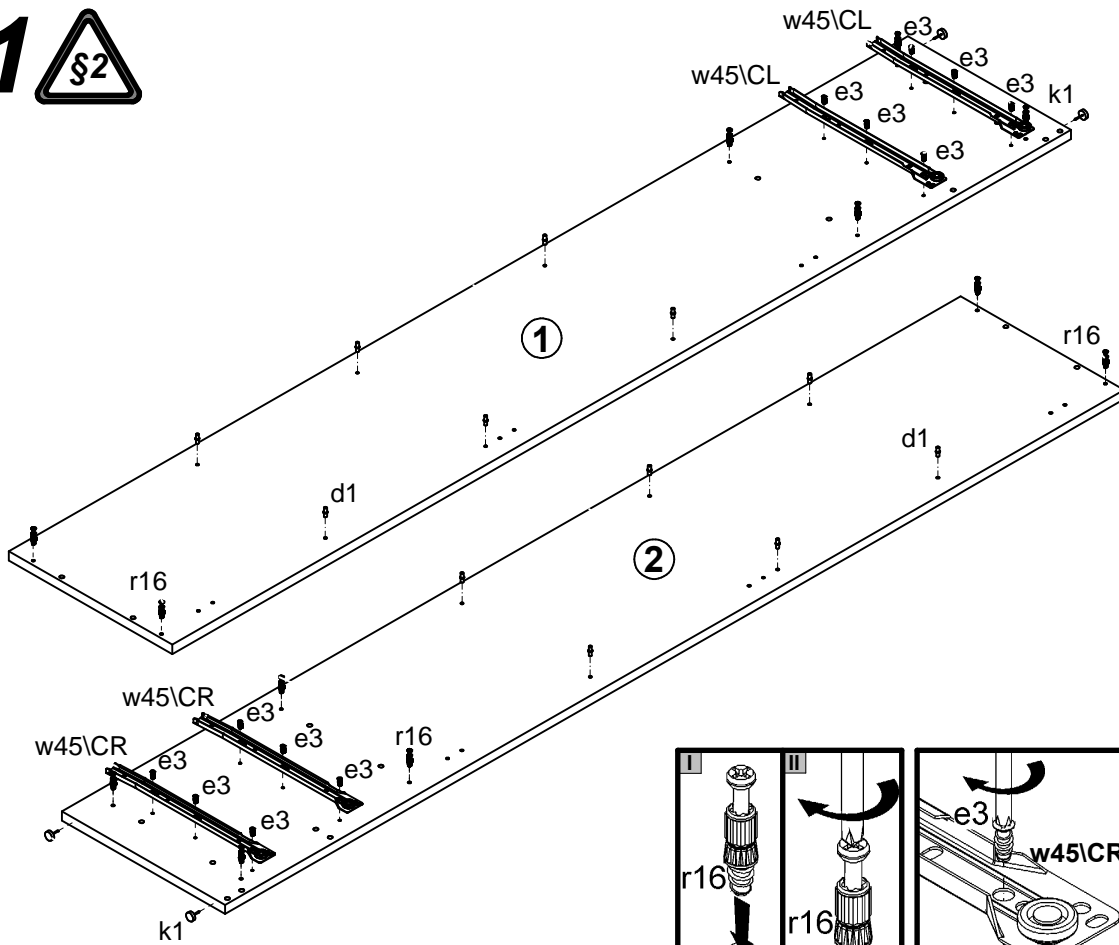

2 

