

CHARLOTTA

S96-KOM4S/9/6

A	B	C	D	
1	S96-107	760	422	2/3
2	S96-108	760	422	2/3
3	S96-205	577	448	1/3
4	S96-206	555	435	1/3
5	S96-404	191	51	2/3
6	S96-405	305	51	2/3
7	S96-501	350	120	2/3
8	S96-502	350	120	2/3
9	S96-507	406	120	2/3
10	S96-550	117	117	1/3
11	S96-902	416	348	2/3
12	S96-9903	788	511	2/3

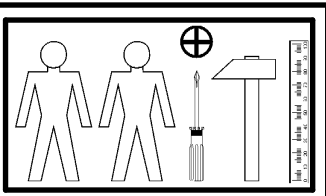
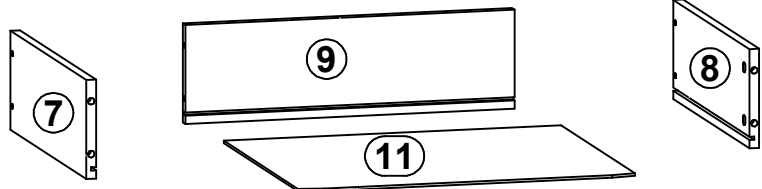
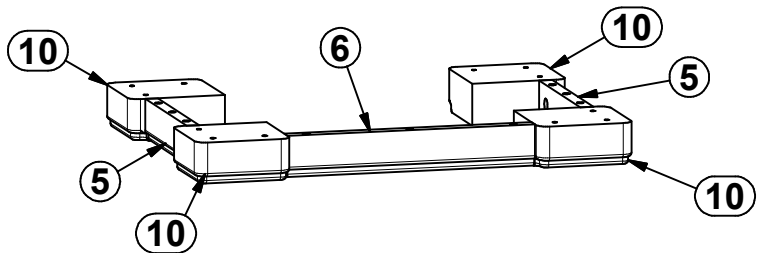
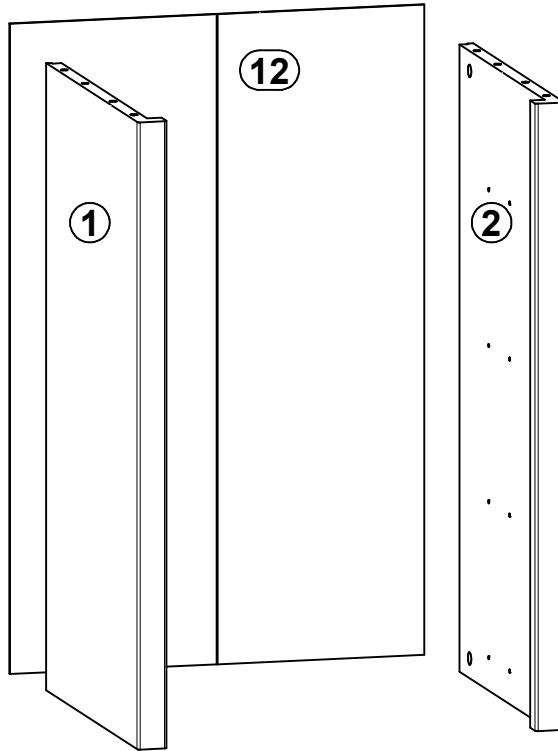
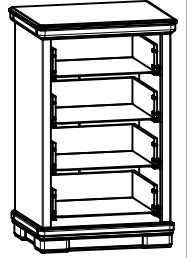
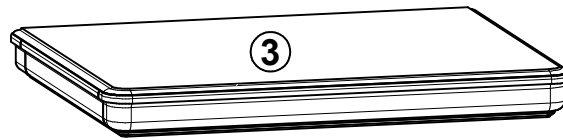

24x φ6x30 mm e16	11x φ8x30 mm f1	16x φ6.5x40 mm f25	28x l1	12x φ4x55 mm p13	16x φ3x12 mm p54	14x φ1.5x12mm #16 r1	16x φ12x10.5mm #12 r15	30x r16
2x ø16 s2	24x h=18 mm w36	4x 350 mm w45\CL	4x 350 mm w45\CR	4x 350 mm w45\DL	4x 350 mm w45\DR	1x n26\1	1x φ3.5x16 mm p38	

1

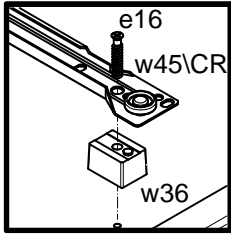
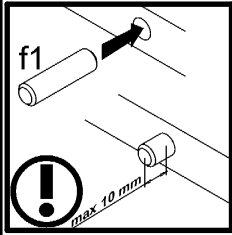
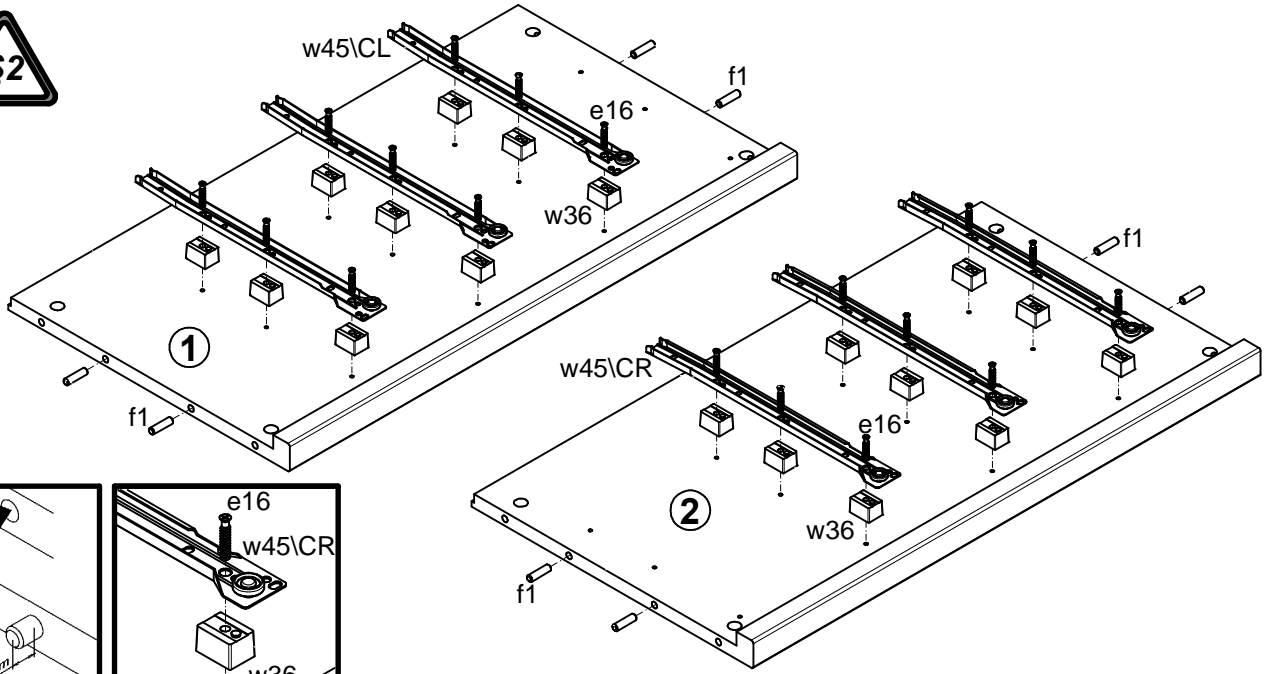

2

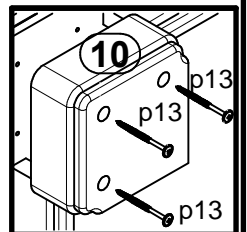
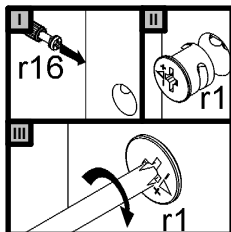
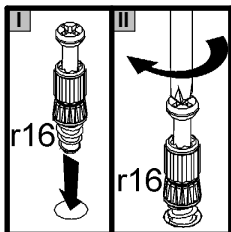
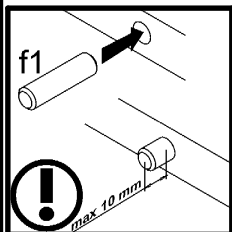
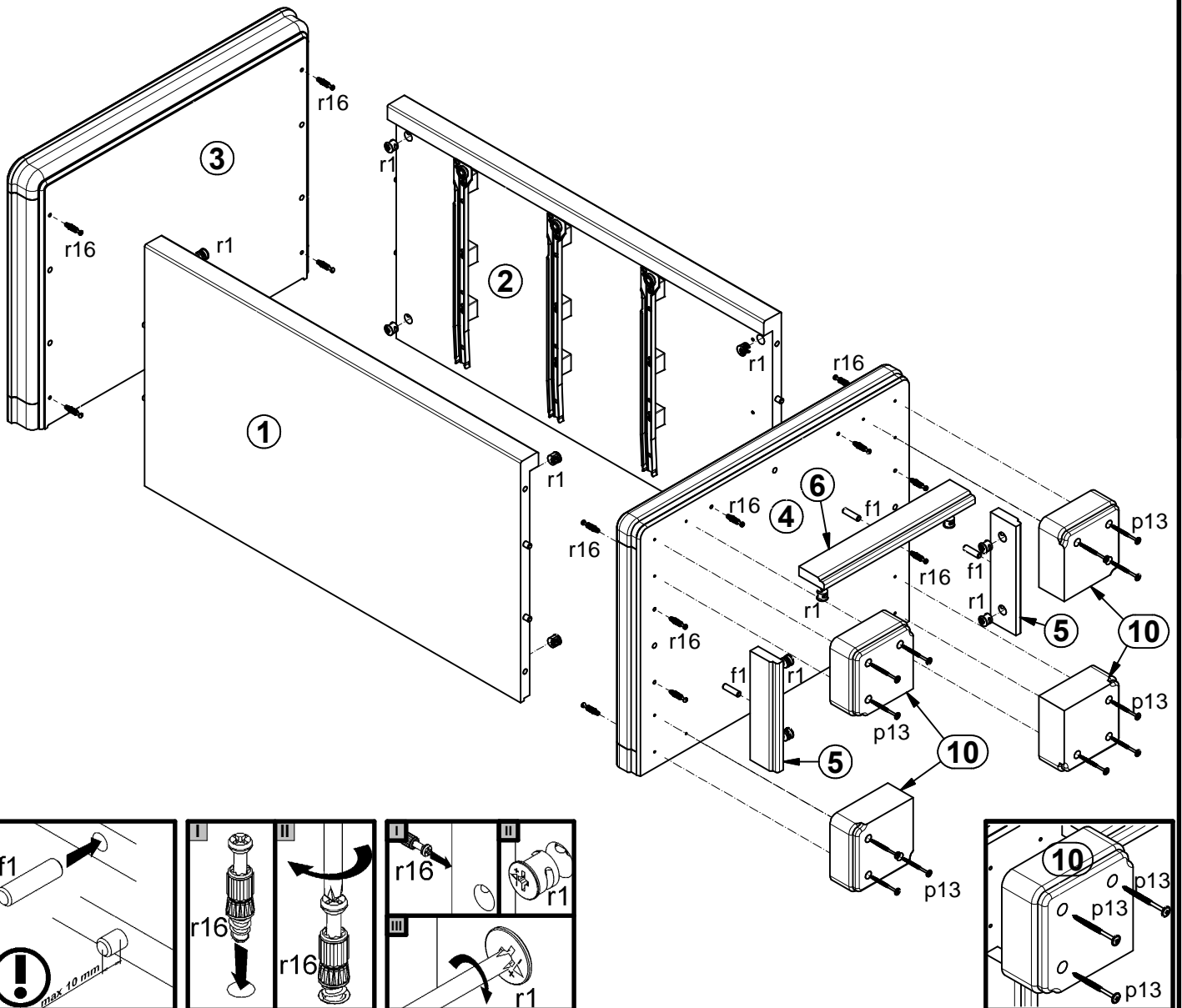

3

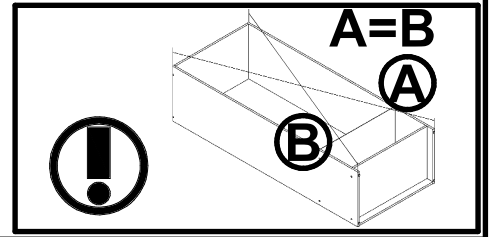
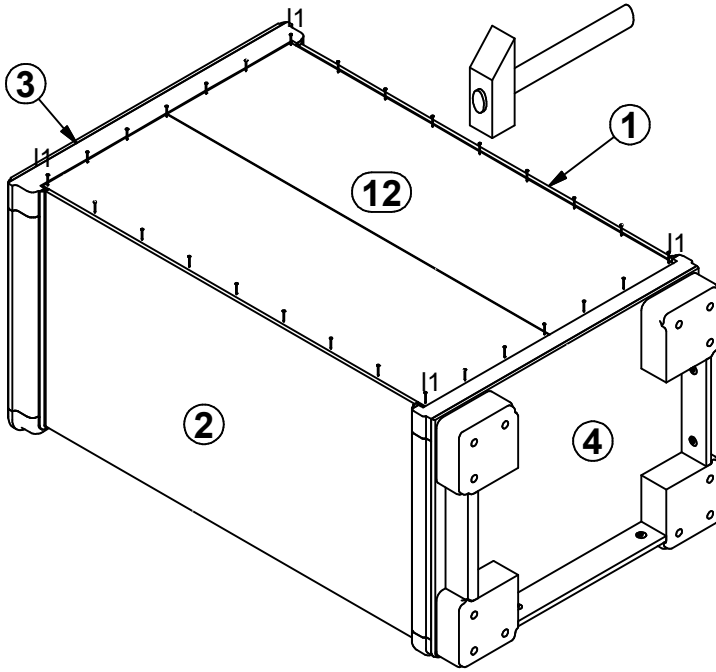

4

